



Product Book



Actual colors may differ from those shown due to the printing process.
Check Model Home samples for actual colors.

Table of Contents



Exterior Doors & Windows

Entry Doors.....	<u>4</u>
Entry Locks.....	<u>12</u>
Patio Doors.....	<u>18</u>
Andersen 200 Series.....	<u>28</u>
Andersen 400 Series.....	<u>33</u>
Silverline Series.....	<u>30</u>

Interior Doors, Trim & Stairs

Interior Doors.....	<u>35</u>
Interior Door Looks & Hardware.....	<u>40</u>
Barn Door.....	<u>45</u>
Interior Trim.....	<u>46</u>
Crown & Chair Rail.....	<u>69</u>
Bullnose Option.....	<u>70</u>
Cased Openings.....	<u>71</u>
Stain Selections.....	<u>49</u>
Stair Railings.....	<u>50</u>

Flooring

Carpet.....	<u>52</u>
Vinyl Floor Tile.....	<u>60</u>
Vinyl Floor Plank.....	<u>62</u>

Interior Paint..... 67

Closet Shelving..... 68

Electrical & Lighting

Wiring.....	<u>73</u>
LED Lighting.....	<u>75</u>
Bedroom Lighting.....	<u>76</u>
Living/Entry Lighting.....	<u>77</u>
Entry/Dining Lighting.....	<u>79</u>
Wall Sconces.....	<u>87</u>
Electrical Panel.....	<u>89</u>
USB Charging & Communication Outlet.....	<u>90</u>

Cabinetry

Standard Overlay vs. Full Overlay.....	<u>91</u>
Door Styles.....	<u>92</u>
Wood Characteristics.....	<u>103</u>
Stain Selections.....	<u>104</u>
Paint Selections.....	<u>112</u>
Glass & Mullion Options.....	<u>114</u>
KCMA - Quality & Environmental Impact	<u>119</u>
Cabinet Options.....	<u>121</u>
Cabinet Knobs & Pulls.....	<u>124</u>
Tile Backsplash Option.....	<u>127</u>

Kitchen Plumbing

Kitchen Faucets.....	<u>129</u>
Kitchen Sink Strainers.....	<u>136</u>

Kitchen Countertops with Sink Options

Formica Sinks.....	<u>137</u>
Formica Tops.....	<u>142</u>
Solid Surface Sinks.....	<u>150</u>
Solid Surface Tops.....	<u>151</u>
Granite & Quartz Sinks.....	<u>156</u>
Granite Tops.....	<u>160</u>
Quartz Tops.....	<u>162</u>

Kitchen Lighting & Appliances

LED Undercabinet Lights.....	<u>167</u>
Island Pendants.....	<u>168</u>
Undercabinet Range Hoods.....	<u>171</u>
Vent Hoods.....	<u>173</u>
Microwave with Vent.....	<u>175</u>
Dishwashers.....	<u>176</u>
.	<u>176</u>
Disposals.....	<u>177</u>
....	<u>177</u>
Ice-Maker Hook-Up.....	<u>178</u>

Table of Contents



Bathroom Vanities

Vanity Sinks for Formica.....	179
Vanity Sinks with Integrated Sink for Solid Surface.....	183
Vanity Sinks for Granite & Quartz.....	184
Marble Top with Integrated Sink.....	185
Lavatory Faucets.....	187
Vanity Lights.....	212
Vanity Mirrors.....	217
Bath Fans.....	219
Bath Accessories.....	267

Bathroom Plumbing

Pedestal Sink.....	266
Tub & Shower Trim.....	192
Shower Trim.....	201
Handheld Shower.....	206
Roman Tub Trim.....	207
Toilets.....	264

Tubs & Showers

Tub & Shower.....	223
Bathtubs.....	228
Stand-Alone Shower with Semi-Frameless Door.....	240
Shower with Hinged Shower Door.....	247
Walk-in Shower Package.....	251
Walk-in Shower Trim.....	254
Walk-in Shower Tile.....	259
Corner Shelves.....	262
Tile Edge Trim.....	263

Utility Room

Water Heater.....	277
Utility Tub & Faucet.....	278

Exterior

Vinyl Lap Siding .42.....	280
Vinyl Lap Siding .44.....	282
Vinyl Shakes in Gable.....	290
Window Lineals.....	281
Shutters.....	283
Shingles.....	284
Exterior Lights.....	288
Dormers.....	292

Product Manufacturers.....	295
-----------------------------------	---------------------

ENTRY DOORS
Standard



**BELLEVILLE 6-PANEL
SMOOTH FIBERGLASS
BLS-6P**

ENTRY DOORS

Optional



**BELLEVILLE 6-PANEL
SMOOTH FIBERGLASS**
BLS-6P with Single Sidelite
BLS-129-03E-1



**BELLEVILLE 6-PANEL
SMOOTH FIBERGLASS**
BLS-6P with Double Sidelite
BLS-129-03E-1

Belleville Smooth Fiberglass Clear Glass / External Grilles

Optional



HALF LITE 2-PANEL
BLS-106-010-2
with Single Sidelite
BLS-129-03E-1



HALF LITE 2-PANEL
BLS-106-010-2
with Double Sidelite
BLS-129-03E-1



HALF LITE 2-PANEL
BLS-106-010-2



9-LITE 2-PANEL
BLS-106-09E-2
with Single Sidelite
BLS-129-03E-1



9-LITE 2-PANEL
BLS-106-09E-2
with Double Sidelite
BLS-129-03E-1



9-LITE 2-PANEL
BLS-106-09E-2 6

Belleville Smooth Fiberglass Clear Glass / External Grilles Optional



FULL LITE
BLS-122-010-X
with Single Sidelite
BLS-151-010-X



FULL LITE
BLS-122-010-X
with Double Sidelite
BLS-151-010-X



FULL LITE
BLS-122-010-X



15-LITE
BLS-122-015-X
with Single Sidelite
BLS-151-05E-X

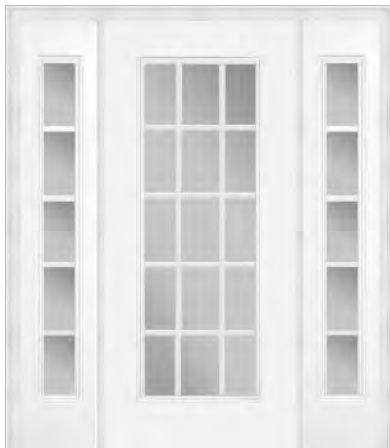

15-LITE
BLS-122-015-X
with Double Sidelite
BLS-151-05E-X



15-LITE
BLS-122-015-X ⁷

Belleville & Heritage Smooth Fiberglass Clear Glass / External Grilles

Optional



FAN LITE 4-PANEL
BLS-135-05E-4
with Single Sidelite
BLS-129-03E-1



FAN LITE 4-PANEL
BLS-135-05E-4
with Double Sidelite
BLS-129-03E-1



FAN LITE 4-PANEL
BLS-135-05E-4



CRAFTSMAN 3-LITE
HGS-217-03E-2C
with Single Sidelite
HGS-617-010-1



CRAFTSMAN 3-LITE
HGS-217-03E-2C
with Double Sidelite
HGS-617-010-1



CRAFTSMAN 3-LITE
HGS-217-03E-2C ⁸

GEORGIAN GLASS with Platinum Caming

Optional



1/2 LITE GEORGIAN 2-PANEL
BLS-106-517-2



1/2 LITE GEORGIAN 2-PANEL
BLS-106-517-2
with Single Sidelite
BLS-129-517-1



1/2 LITE GEORGIAN 2-PANEL
BLS-106-517-2
with Double Sidelite
BLS-129-517-1

Belleville Smooth Fiberglass Georgian Glass, Platinum Caming Optional



**¾ GEORGIAN
2-PANEL**
BLS-404-517-2
with Single Sidelite
BLS-450-517-1



**¾ GEORGIAN
2-PANEL**
BLS-404-517-2
with Double Sidelite
BLS-450-517-1



¾ GEORGIAN 2-PANEL
BLS-404-517-2



**¾ GEORGIAN OVAL
2-PANEL**
BLS-304-517-3
with Single Sidelite
BLS-450-517-1



**¾ GEORGIAN OVAL
2-PANEL**
BLS-304-517-3
with Double Sidelite
BLS-450-517-1



**¾ GEORGIAN OVAL
2-PANEL**
BLS-304-517-3

20 MINUTE FIRE-RATED ENTRY DOORS

Optional



**HD STEEL
6-PANEL
MHD-6P**



**STA-TRU HD STEEL
CRAFTSMAN 3-PANEL
SHD-3P**



**HERITAGE FIBERGLASS
CRAFTSMAN 3-PANEL
HGS-3C**

TUSTIN ENTRY LOCKS Standard



SATIN NICKEL



VENETIAN BRONZE



Optional



MATTE BLACK



CHELSEA ENTRY LOCK with Tustin Interior Lever
Optional



SATIN NICKEL



VENETIAN BRONZE

HALIFAX ENTRY LOCKS

Optional



SATIN NICKEL



VENETIAN BRONZE



MATTE BLACK

VANCOUVER ENTRY LOCK with Halifax Interior Lever
Optional

SATIN NICKEL



VENETIAN BRONZE



MATTE BLACK



Kwikset

SMARTKEY® RE-KEY TECHNOLOGY

THE LOCK YOU CAN RE-KEY IN SECONDS

Now you can re-key your locks, quickly & securely, without the extra hassle & cost of removing the lock from the door.



- Increase jobsite security
- Control jobsite keys
- Reduce callbacks / simple on site re-keying
- Homeowner peace of mind



1 Insert functioning key & turn 1/4 turn clockwise.

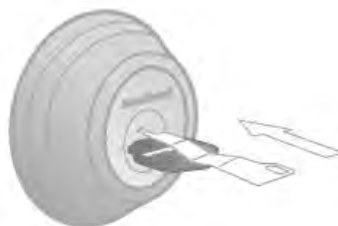

2 Insert & remove the SmartKey learn tool. Remove functioning key.



3 Insert new key & turn 1/2 turn counter-clockwise. Done. *Your lock is now re-keyed!*



Functioning Key



SmartKey Learn Tool



New Key

! You must have your functioning key & the learn tool for the system to work.

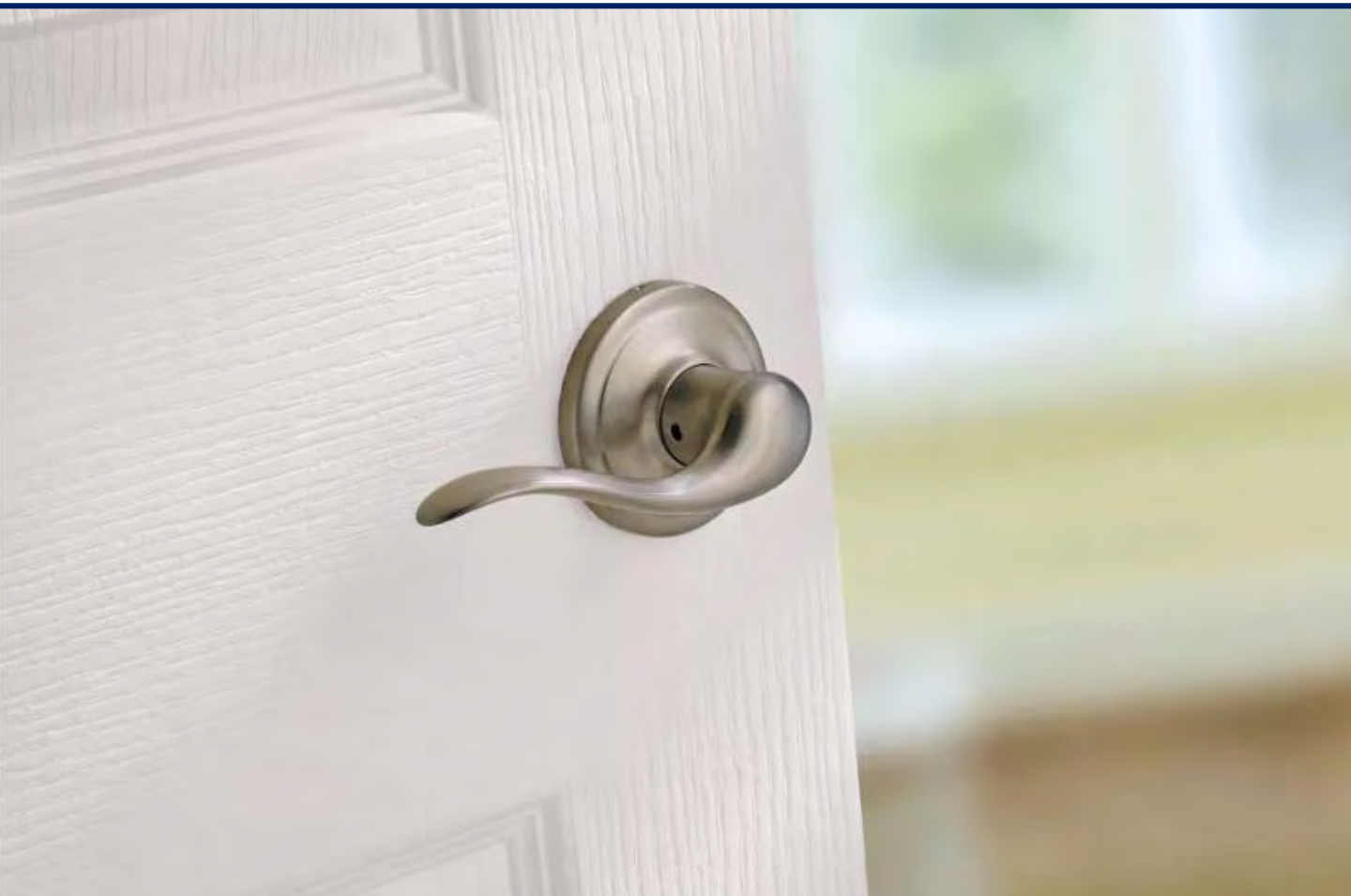

Bacteria can double every 20 minutes on unprotected surfaces, but Kwikset Door Hardware with Microban product protection works to continuously fight off microbes.

Benefits of Kwikset® Door Hardware with Microban® Technology

- Door hardware is 99.9% cleaner than knobs without Microban.
- The antimicrobial coating last for the lifetime of the hardware finish, so you can worry less and feel more secure in your home.
- No need to clean door hardware - 24/7 Antimicrobial protection.

Kwikset with Microban product protection is effective against a broad spectrum of bacteria.



*Limited to bacteria Microban is effective against.

200 SERIES PATIO DOORS WITH LOW-E GLASS PERMA-SHIELD GLIDING

Standard (with most plans)

200 Series Patio Doors

A tried and true classic, these doors are protected in and out with rigid vinyl cladding to give homes a contemporary look and energy-saving performance, while keeping maintenance to a minimum. *Interior color matches exterior finish.*

Smooth Operation

Dual ball-bearing rollers on door panels provide smooth gliding operation with self-contained leveling adjusters.

SmartSun™ Glass

Has the benefits of Low-E glass, plus it helps shield your home from the sun's heat and filters out 95% of harmful UV rays while letting sunlight shine through.



Color Selections

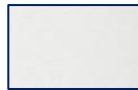

WHITE
Standard

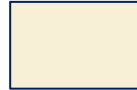

CANVAS
Optional



SANDTONE
Optional



TERRATONE
Optional



DARK BRONZE
Optional



BLACK
Optional

200 SERIES PATIO DOORS WITH LOW-E GLASS

Standard (with most plans)

Clear Glass
Standard



Colonial Grilles
Optional



Prairie Grilles
Optional



Enhanced Security

The unique Andersen® reachout locking hardware pulls the door panel snugly into the jamb for a weathertight seal and enhanced security. An Auxiliary Foot Lock adds an extra measure of security when the door is in a locked position. Lock can be set so the door is fully closed or partially open to provide a secure venting position. *Keyed locks are optional, Auxiliary Foot Locks are standard.*

Internal Blinds
Optional in White Only



Tribeca Hardware



WHITE
Standard

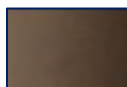

STONE
Optional

200 SERIES PATIO DOORS WITH LOW-E GLASS ISPD HINGED

Optional

200 Series Hinged Patio Doors

Give you traditional French styling with the convenience and durability of fiberglass door panels. Low-maintenance aluminum protects the frame and sill from the elements.

Available in two panel configurations. *All doors have white interiors.*

Enhanced Security

The mortised lock and hook design provides strength and added security compared to bored locks with standard deadbolts. *Keyed locks are optional.*

SmartSun™ Glass

Has the benefits of Low-E glass, plus it helps shield your home from the sun's heat and filters out 95% of harmful UV rays while letting sunlight shine through.

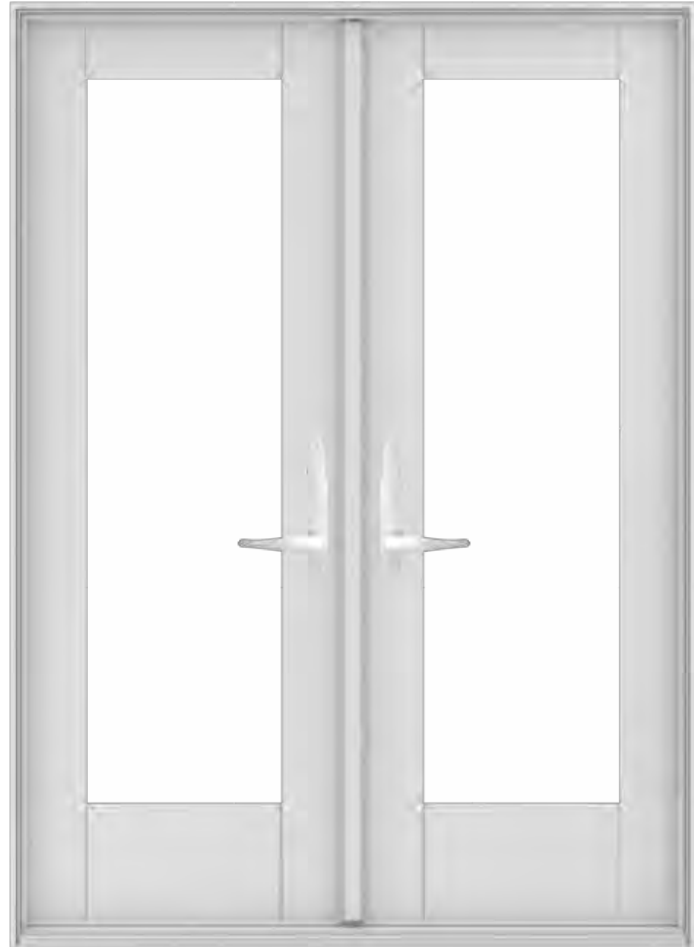

Exterior Door Color Selections

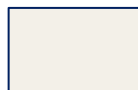

WHITE
Standard



SANDTONE
Optional



TERRATONE
Optional

200 SERIES PATIO DOORS WITH LOW-E GLASS ISPD HINGED

Optional

Clear Glass



Colonial Grilles



Prairie Grilles



Interior Door Finish Selection



WHITE
Standard



Tribeca Hardware



WHITE
Standard

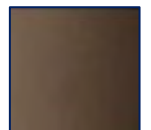

STONE
Optional

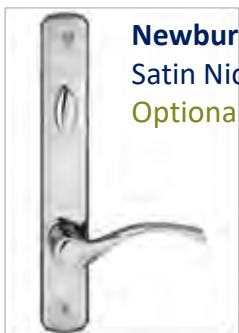

Newbury
Satin Nickel
Optional

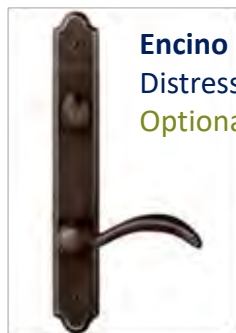

Encino
Distressed Bronze
Optional



Albany
Black
Optional

SILVERLINE VINYL LOW-E with ARGON GAS PATIO DOOR

Optional



V3 Series

SILVERLINE VINYL LOW-E with ARGON GAS PATIO DOOR

Optional

Colonial Grilles

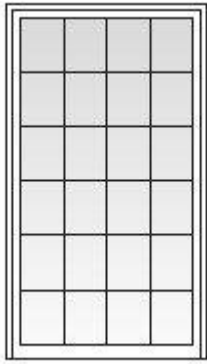

Prairie Grilles

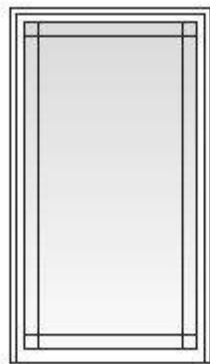

Exterior & Interior Door Color Selections

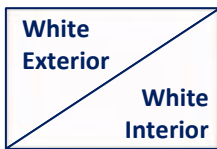

Standard



Optional



Optional

NEW



Optional



Color Matched Hardware

White, Sandstone, Dark Bronze or Black
Standard

400 SERIES DOORS with LOW-E GLASS FRENCHWOOD GLIDING

Optional

Maximum Strength

Mortise-and-tenon joints prevent panel sag and maintain smooth operation.

Smooth Operation

Dual ball-bearing rollers on door panels provide smooth gliding operation with self-contained leveling adjusters.

Enhanced Security

The unique Andersen[®] reachout locking hardware pulls the door panel snugly into the jamb for a weathertight seal and enhanced security.



SmartSun™ Glass

Has the benefits of Low-E glass, plus it helps shield your home from the sun's heat and filters out 95% of harmful UV rays while letting sunlight shine through.

Exterior Door Color Selections

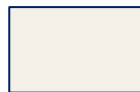

WHITE
Standard



SANDTONE
Optional



TERRATONE
Optional

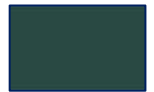

FOREST GREEN
Optional

400 SERIES DOORS with LOW-E GLASS FRENCHWOOD GLIDING

Optional

Clear Glass



Colonial Grilles



Prairie Grilles



Interior Door Finish Selections



WHITE
Standard



PINE
Standard

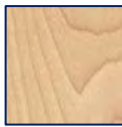

MAPLE
Optional



OAK
Optional

Tribeca Hardware



WHITE
Standard

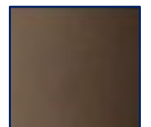

STONE
Optional



Newbury
Satin Nickel
Optional



Encino
Distressed Bronze
Optional



Albany
Black
Optional

400 SERIES DOORS with LOW-E GLASS FRENCHWOOD HINGED

Optional

Available in inswing & outswing

Maximum Strength

Mortise-and-tenon joints prevent panel sag and maintain smooth operation.

Adjustable Hinges

Adjustable hinges are standard on inswing patio doors and have ball-bearing pivots for smooth, frictionless movement. Features easy horizontal and vertical adjustment, plus quick-release feature for easy panel removal.

Enhanced Security

The multi-point locking system, with a hook bolt above & below the center dead bolt, provides a weathertight seal & enhanced security.

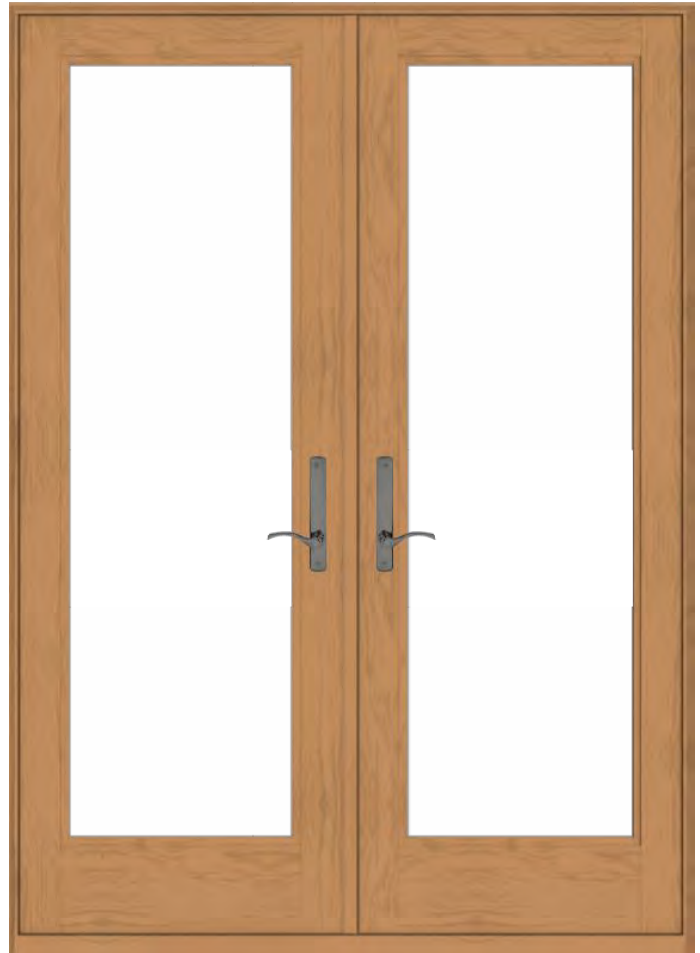

SmartSun™ Glass

Has the benefits of Low-E glass, plus it helps shield your home from the sun's heat and filters out 95% of harmful UV rays while letting sunlight shine through.

Exterior Door Color Selections

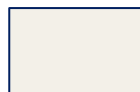

WHITE
Standard



SANDTONE
Optional



TERRATONE
Optional



FOREST GREEN
Optional

400 SERIES DOORS with LOW-E GLASS FRENCHWOOD HINGED

Optional

Clear Glass



Colonial Grilles



Prairie Grilles



Interior Door Finish Selections



WHITE
Standard



PINE
Optional



MAPLE
Optional



OAK
Optional



Tribeca Hardware



WHITE
Standard

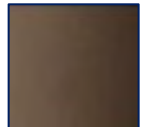

STONE
Optional

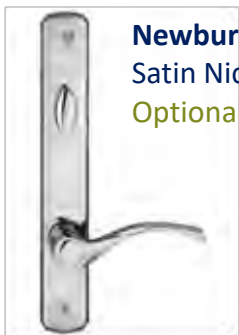

Newbury
Satin Nickel
Optional

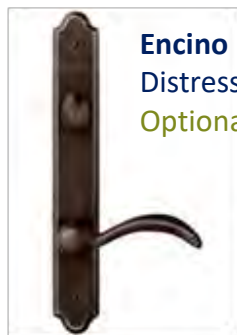

Encino
Distressed Bronze
Optional

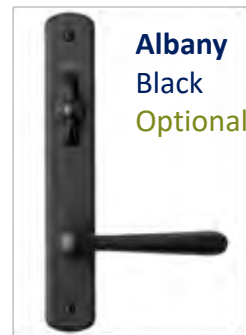

Albany
Black
Optional

ANDERSEN 200 SERIES WINDOWS with LOW-E GLASS

Standard

Double-Hung Windows

These windows are weather resistant for greater comfort & efficiency. The exclusive Andersen Perma-Shield[®] system gives your windows a tough, protective shell that safeguards the wood inside. It repels water, resists dents & stays beautiful for years.

Double-hung windows tilt-in for easy cleaning. Narrow profiles maximize light and view. Full insect screens are included. *Clear pine interiors or white interior finish.*

SmartSun[™] Glass

Most people can enjoy optimal energy performance and comfort with Low-E/Low-E4[®] glass. Low-E glass reflects heat in the summer and helps keep heat inside in the winter, making this a good choice in climates where both heating and cooling costs are a concern. Tempered safety glass available in bathrooms.

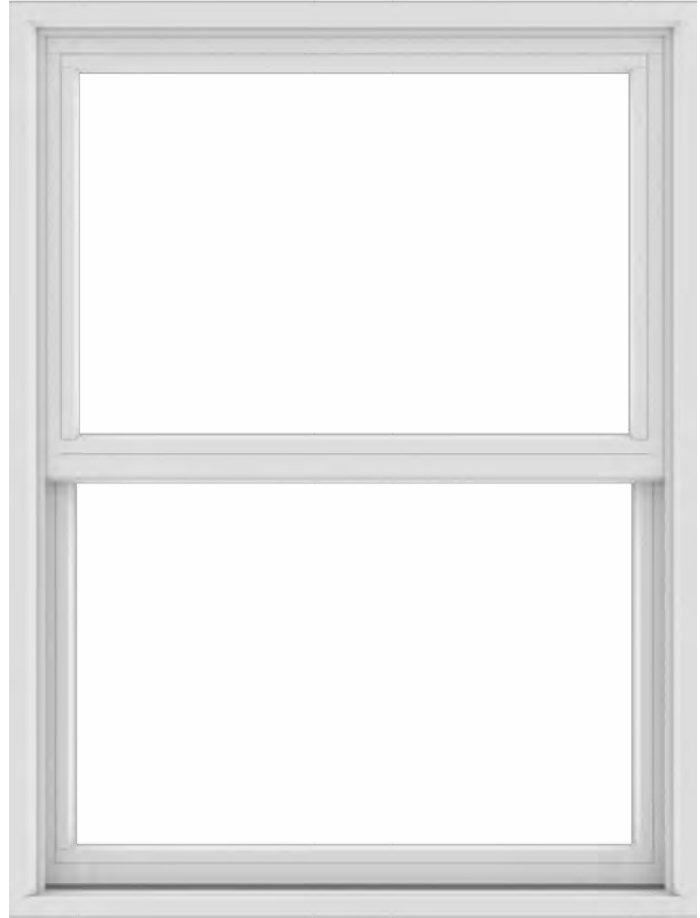

Exterior Window Color Selections

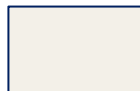

WHITE
Standard



SANDTONE
Optional

ANDERSEN 200 SERIES WINDOWS with LOW-E GLASS

Standard

Colonial Grilles

Optional



Prairie Grilles

Optional



Interior Window Color Selections

Optional



WHITE
Standard



PINE
Optional



Equal Lite Grilles

Optional

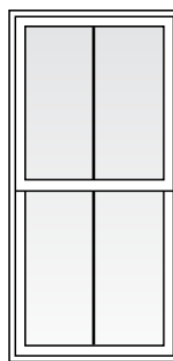

2W X 1H

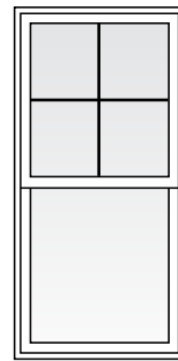

2W X 2H

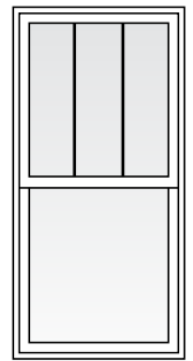

3W X 1H

Lock & Keeper Finish Selections



WHITE
Standard



STONE
Optional

SILVERLINE VINYL WINDOWS with LOW-E GLASS & ARGON GAS

Optional



Silver Line® Single-Hung Windows

- Simple design blends with virtually any décor
- Tilt-in bottom sash for easy cleaning
- Fusion-welded vinyl for durability
- Integral J-channel is optional for attractive trimming of exterior siding



SILVERLINE VINYL WINDOWS with LOW-E GLASS & ARGON GAS

Optional



Silver Line® Double-Hung Windows

- Colonial brick mould design for classic styling
- Tilt-in top and bottom sash for easy cleaning
- Fusion-welded, heavy-duty vinyl for strength and durability
- Integral J-channel is optional for attractive trimming of exterior siding



SILVERLINE VINYL WINDOWS with LOW-E GLASS & ARGON GAS

Optional

Colonial Grilles

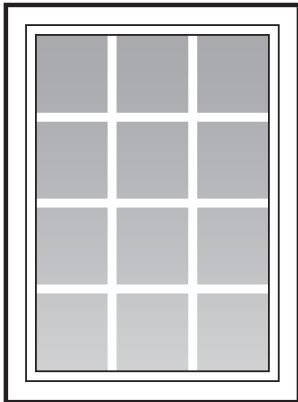

Prairie Grilles

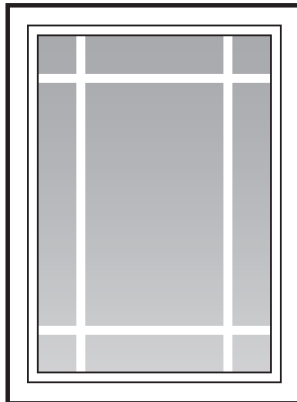

Equal Lite Grilles

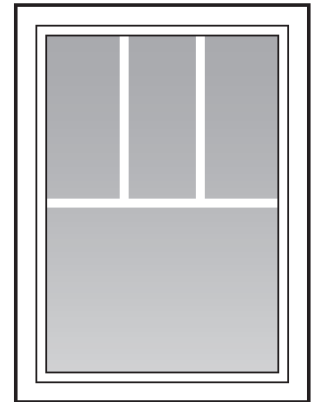

Exterior & Interior Door Color Selections



Standard

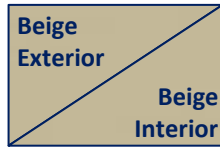

Optional



Optional



Optional



Optional

NEW



Color-Coordinated Lock & Keeper

White, Sandstone, Dark Bronze or Black

ANDERSEN 400 SERIES WINDOWS with LOW-E4 GLASS

Optional

Double-Hung Windows

These windows have two operating sashes that move up and down allowing for ventilation on the top, bottom or both. The sash tilts in for easy cleaning from the inside of your home. It's made of wood protected by a vinyl exterior. Virtually Maintenance Free. Dual-layer, compressible bulb weather-stripping seals out dust, wind & water. Full insect screens are included. *Black & Dark Bronze interior available only with matching exterior color.*

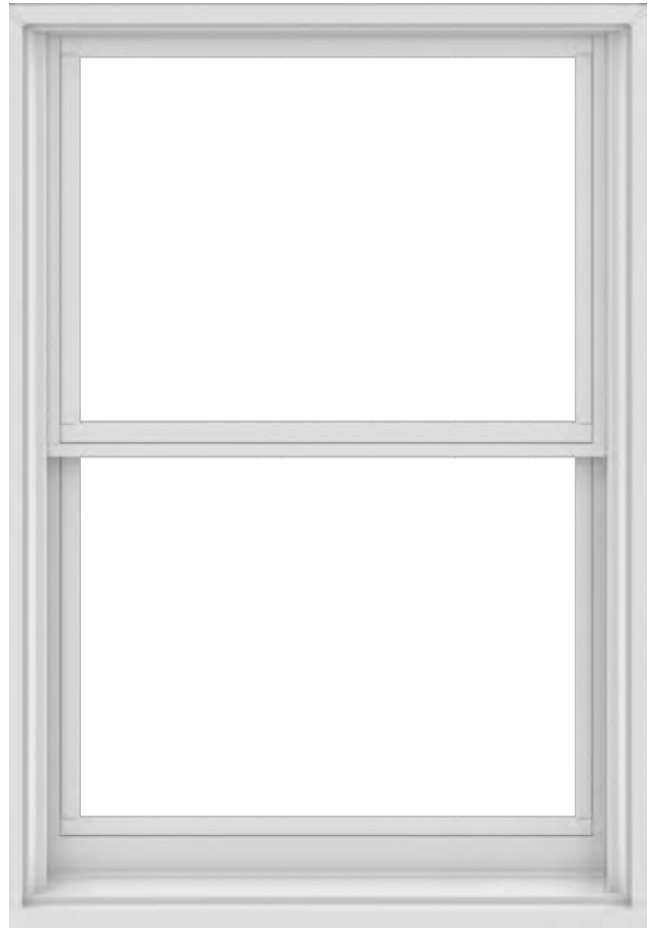

SmartSun™ Glass

Most people can enjoy optimal energy performance and comfort with Low-E/Low-E4® glass. Low-E glass reflects heat in the summer and helps keep heat inside in the winter, making this a good choice in climates where both heating and cooling costs are a concern. Tempered safety glass available in bathrooms.

Exterior Window Color Selections

			
WHITE Standard	CANVAS Optional	SANDTONE Optional	TERRATONE Optional
			
MATCHING INTERIOR ONLY DARK BRONZE Optional	MATCHING INTERIOR ONLY BLACK Optional	FOREST GREEN Optional	

ANDERSEN 400 SERIES WINDOWS with LOW-E4 GLASS

Optional

Colonial Grilles



Prairie Grilles



Interior Window Color Selections



WHITE
Optional



PINE
Optional



DK BRONZE
Optional



BLACK
Optional



Equal Lite Grilles

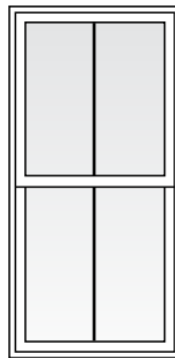

2W X 1H

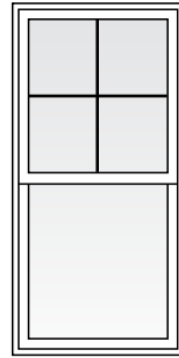

2W X 2H

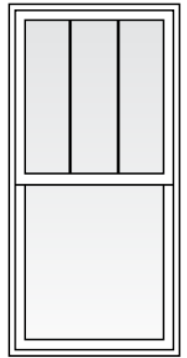

3W X 1H

Lock & Keeper Finish Selections



WHITE
Optional



BLACK
Optional



STONE
Optional



GOLD DUST
Optional

INTERIOR DOORS PAINTED POLAR WHITE (shown primed) Standard



COLONIST 6-PANEL

6'8 HOLLOW CORE STANDARD

SOLID CORE OPTIONAL

SMOOTH, COVE & BEAD STICKING



CAIMAN 2-PANEL ARCH

6'8 HOLLOW CORE STANDARD

SOLID CORE OPTIONAL

SMOOTH, COVE & BEAD STICKING

INTERIOR DOORS PAINTED POLAR WHITE (shown primed)

Optional



COVENTRY 4-PANEL

6'8 HOLLOW or SOLID CORE OPTIONAL
SMOOTH, COVE & BEAD STICKING



CARRARA 2-PANEL

6'8 HOLLOW CORE or SOLID CORE OPTIONAL
SMOOTH, COVE & BEAD STICKING

INTERIOR DOORS PAINTED POLAR WHITE (shown primed)

Optional



SANTE FE 2-PANEL ARCH PLANK

6'8 HOLLOW CORE or SOLID CORE OPTIONAL
SMOOTH, OVOLO STICKING



CRAFTSMAN 3-PANEL

6'8 HOLLOW CORE or SOLID CORE OPTIONAL
SMOOTH, CRAFTSMAN STICKING

STAINED INTERIOR DOORS

Optional

See Stain Selections Page
for Color Selections
[Pg.49](#)



FLUSH BIRCH VENEER

6'8 HOLLOW CORE
or SOLID CORE



6-PANEL POPLAR*

SOLID CORE



15-LITE POPLAR*

SOLID CORE

STAINED INTERIOR DOORS

Optional

See Stain Selections Page
for Color Selections

[Pg.49](#)

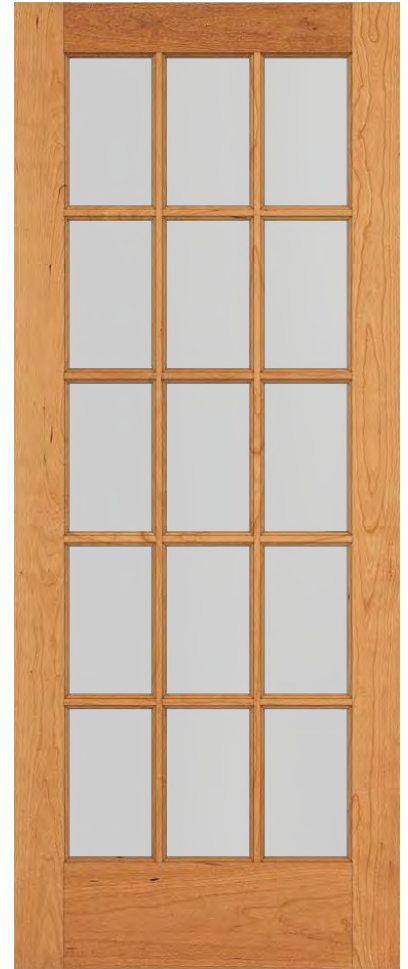

FLUSH OAK

6'8 HOLLOW CORE

or SOLID CORE

6-PANEL OAK

6'8 SOLID CORE

15-LITE OAK

6'8 SOLID CORE

INTERIOR LOCKS – Tustin Lever
Standard

SATIN NICKEL



VENETIAN BRONZE



Optional

MATTE BLACK



INTERIOR LOCKS – Halifax Lever

Optional



SATIN NICKEL DOOR HARDWARE

Standard Finish



**PASSAGE
POCKET DOOR PULL**



2-1/8" FINGER PULL



**PRIVACY
POCKET DOOR PULL**



**42
RIGID DOOR STOP**

BRONZE DOOR HARDWARE

Optional Finish



PASSAGE
POCKET DOOR PULL



2-1/8" FINGER PULL



PRIVACY
POCKET DOOR PULL



43
RIGID DOOR STOP

BLACK DOOR HARDWARE

Optional Finish



**PASSAGE
POCKET DOOR PULL**



2-1/8" FINGER PULL



**PRIVACY
POCKET DOOR PULL**



**44
RIGID DOOR STOP**

BARN DOOR with SOFT CLOSE TRACK

Optional



**Optional Handles
Included or Match
Door Levers**

INTERIOR TRIM – FJP Painted Polar White
Standard



WIDE CASING
11/16" X 3-1/4"



WIDE BASE
9/16" x 5-1/4"

INTERIOR TRIM – FJP Painted Polar White
Optional

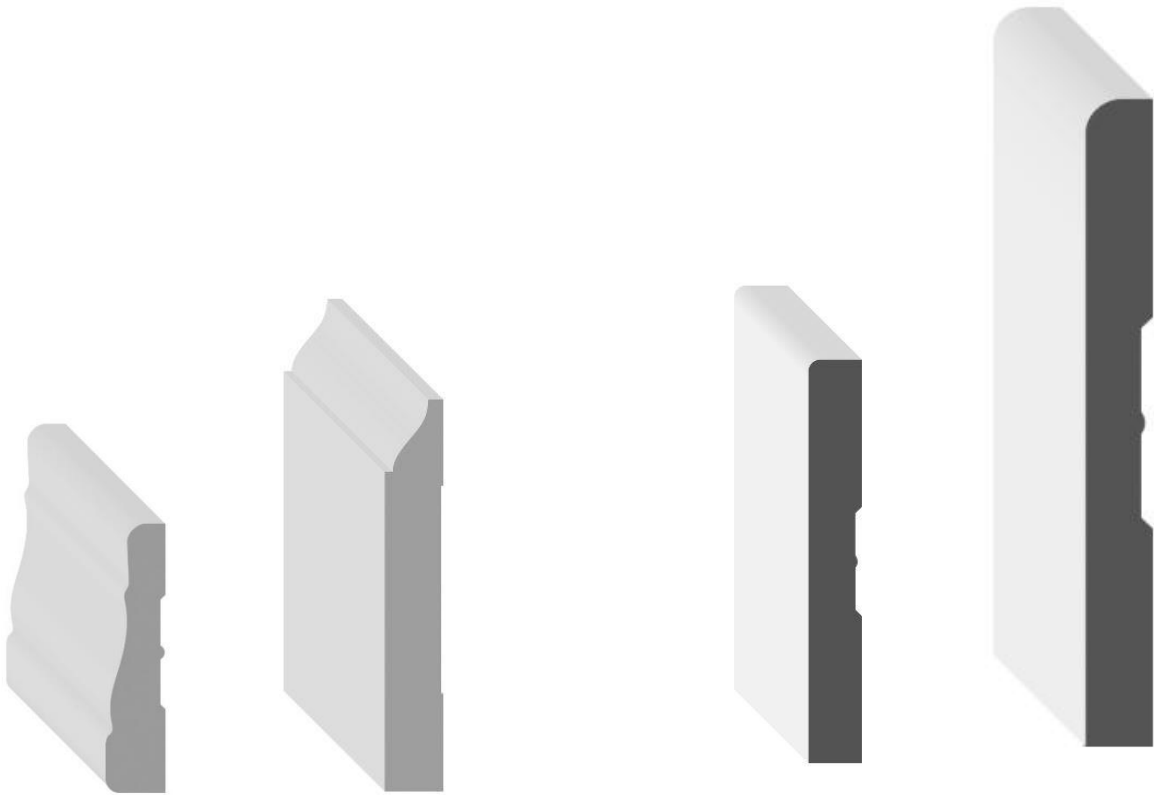

**NARROW
CASING**

11/16" X 2-1/4"

**NARROW
BASE**

9/16" X 3-1/4"

**CRAFTSMAN
CASING**

11/16" X 3-1/2"

**CRAFTSMAN
BASE**

9/16" X 5-1/4"

INTERIOR TRIM – Stained Poplar or Oak

Optional

See Stain Selections Page
for Color Selections

Pg. 49



**NARROW
CASING**

11/16" X 2-1/4"

**NARROW
BASE**

9/16" X 3"

**WIDE
CASING**

9/16" X 3-1/2"

**WIDE
BASE**

9/16" X 4-1/2"

Stain Selections for Poplar or Oak

A horizontal strip of wood with a light, natural finish, showing a smooth grain pattern.

POPLAR SANDALWOOD

A horizontal strip of wood with a medium-brown stain, showing a smooth grain pattern.

POPLAR HAZELNUT/PECAN

A horizontal strip of wood with a dark brown stain, showing a smooth grain pattern.

POPLAR GINGERSNAP/WALNUT

A horizontal strip of wood with a medium-brown stain and a more pronounced, wavy grain pattern.

OAK SANDALWOOD

A horizontal strip of wood with a medium-brown stain and a more pronounced, wavy grain pattern.

OAK PECAN

A horizontal strip of wood with a dark brown stain and a more pronounced, wavy grain pattern.

OAK WALNUT

CLASSIC STAIR RAILINGS

Per Plan

See Stain Selections Page
for Color Selections
[Pg. 49](#)

POPLAR - Standard

OAK - Optional

NEWEL POST LJ-4006RT-P



BALUSETER LJ-5141-P 34,38,42



HAND RAIL 1.75"
LJ-6040-P



STAIR RAIL 1.25" PLOW
LJ-6010P-P



SHOE RAIL 1.25" PLOW
LJ-6045-P



FILLET 1.25"
LJ-6050-P



HAND RAIL 1.75"
LJ-6040-O



STAIR RAIL 1.25" PLOW
LJ-6010P-O



SHOE RAIL 1.25" PLOW
LJ-6045-O



FILLET 1.25"
LJ-6050-O



NEWEL POST LJ-4006RT-O



BALUSETER LJ-5141-O 34,38,42















CHALET CONTEMPORARY STAIR RAILINGS

See Stain Selections Page
for Color Selections

[Pg.49](#)

POPLAR - Standard

OAK - Optional

<p>NEWEL POST LJ-4001-P</p> 	<p>BALUSETER LJ-5060-P 34,38,42</p> 	<p>HAND RAIL 2.75" LJ-6002-P</p> 	<p>NEWEL POST LJ-4001-O</p> 	<p>BALUSETER LJ-5060-O 34,38,42</p> 	<p>HAND RAIL 2.75" LJ-6002-O</p> 
		<p>STAIR RAIL 1.25" PLOW LJ-6000-P</p> 			<p>STAIR RAIL 1.25" PLOW LJ-6000-O</p> 
		<p>SHOE RAIL 1.25" PLOW LJ-6000S-P</p> 			<p>SHOE RAIL 1.25" PLOW LJ-6000S-O</p> 
		<p>FILLET 1.25" LJ-6000F-P</p> 			<p>FILLET 1.25" LJ-6000F-O</p> 

CARPET – Freshen Up 35oz Standard



CARPET PAD

Standard

Spring™

Bonded Polyurethane Carpet Cushion

Product Description

Foam Density	5.95 pcf
Foam Color	Neutral
Backing Type	Poly
Backing Color	Black
Thickness*	3/8 – 1/2”
Roll Size	30 yd ²
HUD/FHA Certification	Class 1
Warranty	Life of Carpet



*Thickness provided at industry standards within $\pm 1/32$ ” tolerance

Product Features

- CRI Green Label Plus certification
- Made using recycled polyurethane foam and is 100% recyclable

CARPET – Go Softly 35oz Standard



730 TWIG

770 RIVERBANK

250 WHEAT

702 TRAVERTINE

CARPET – Go Softly 35oz Standard

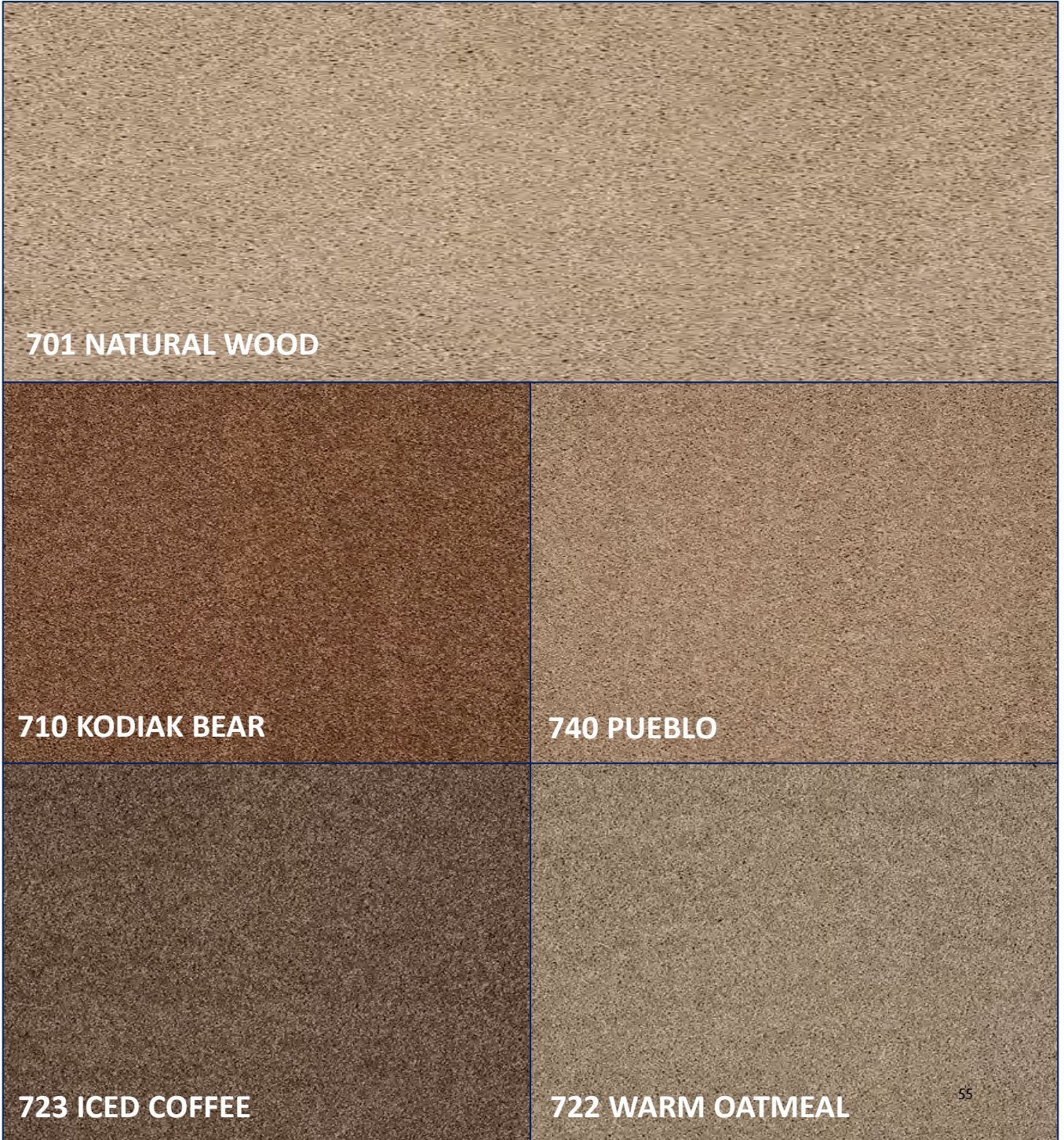

CARPET – Your Choice 25oz

Optional



CARPET – Your Choice 25oz

Optional

702 FAWNS LEAP

701 BUNGALOW

700 WOOD BRIDGE

121 ALMOND TWEED

104 COTTAGE

153 ABALONE

CARPET – Believe It 25oz
Optional



CARPET – Believe It 25oz
Optional



LUXURY VINYL CLICK LOCK FLOOR TILE 12X24
Standard



floorté | **PRO** series



LUXURY VINYL CLICK LOCK FLOOR TILE 12X24

Standard

SOFT
SILENCE
ACOUSTICAL PAD

floorté PRO series



581 RIDGE

162 ARID

585 BOULDER

148 PRAIRIE

LUXURY VINYL CLICK LOCK PLANK 9X59

Optional



floorté PRO series



**BLUE RIDGE PINE
623 EARTHY PINE**



**BLUE RIDGE PINE
812 FOREST PINE**



**CROSS-SAWN PINE
5006 ANTIQUE PINE**

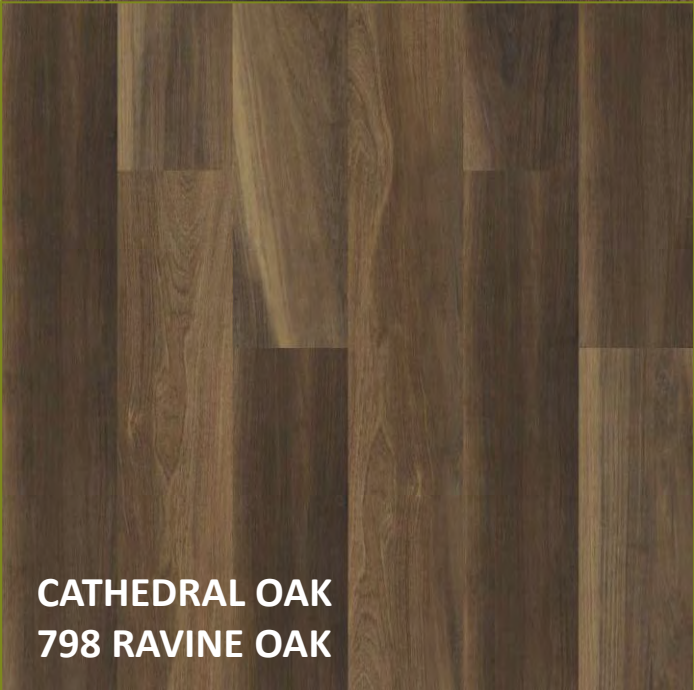

**CATHEDRAL OAK
798 RAVINE OAK**

LUXURY VINYL CLICK LOCK PLANK 9X59

Optional



floorté PRO series



**BLUE RIDGE PINE
5007 LONGLEAF PINE**



**CROSS-SAWN PINE
166 RECLAIMED PINE**



**CROSS-SAWN PINE
554 SALVAGED PINE**



**CROSS-SAWN PINE
164 DISTRESSED PINE**

LUXURY VINYL CLICK LOCK PLANK 9X59

Optional

SOFT
SILENCE
ACOUSTICAL PAD

floorté PRO series



**CATHEDRAL OAK
5009 CHARRED OAK**

**HERITAGE OAK
5004 WYE OAK**



**HERITAGE OAK
742 BUR OAK**

**CATHEDRAL OAK
5008 MISTY OAK**

LUXURY VINYL CLICK LOCK PLANK 9X59

Optional



floorté PRO series

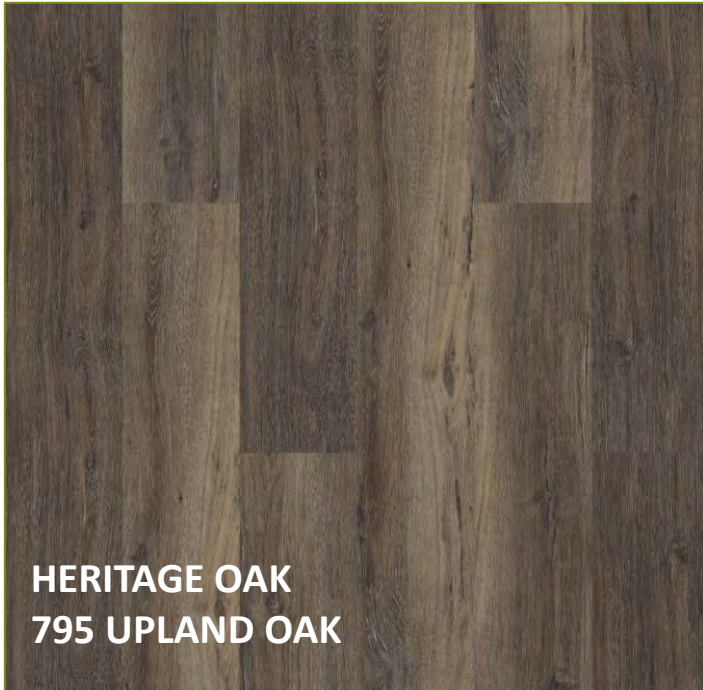

**HERITAGE OAK
795 UPLAND OAK**



**CATHEDRAL OAK
5010 CHESTNUT OAK**



**HERITAGE OAK
5003 SILVER OAK**



**HERITAGE OAK
5005 SANDY OAK**

LUXURY VINYL CLICK LOCK PLANK 9X59

Optional



floorté | PRO series



CATHEDRAL OAK
168 SHAWSHANK OAK

CATHEDRAL OAK
7058 BUFF OAK

CATHEDRAL OAK
2000 NATURAL OAK

CATHEDRAL OAK
699 KHAKI OAK

FLAT INTERIOR PAINT

Standard



The **BEHR PRO PR310 Dead Flat Interior Paint** is versatile with great performance whether brushed, rolled or sprayed. Designed for professionals, it offers superior hide and excellent touch-up in a water-based formula. It also offers low VOC and low Odor in a GreenGuard Gold certified washable flat.

FLAT INTERIOR PAINT

Optional



ProMar® 200 Zero VOC Flat Interior Latex Paint

Professional paint that not only has zero VOCs, but is also available in a variety of colors. All while delivering exceptional durability & touch up. And now, the flat sheen has improved hide & durability, & meets MPI certification.

- Interior Walls Painted in Light Colors (up to 2 colors)
- Interior Walls Painted In Bold (Dark) Colors
- Interior Walls Painted in Additional Colors

SHELF & ROD SHELVING Standard

ClosetMaid's® economical Shelf & Rod shelving provides shelf and hanging space for bedroom, laundry or where extra space is needed. No need to purchase a hang rod, it is constructed into the shelving unit.



- Ventilated wire construction
- Material: Vinyl coated steel
- All shelving SCS® Certified for minimum of 91% recycled content



CROWN or CHAIR RAIL

FJ Painted Polar White, Poplar Stained, Oak Stained

Optional

See Stain Selections Page
for Color Selections

[Pg.49](#)

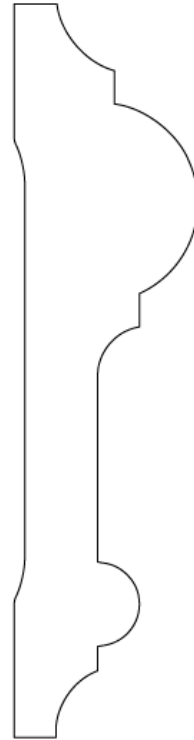
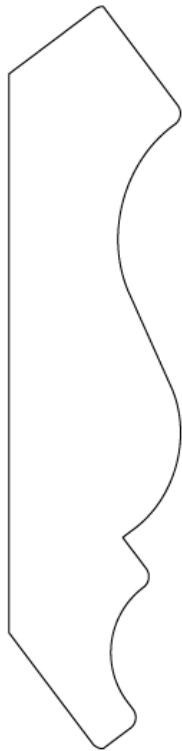

CROWN 3-1/4"

2030

CHAIR RAIL 2-5/8"

4520

DRYWALL BULLNOSE

Optional

NO-COAT 3/4" BULLNOSE

NO-COAT BULLNOSE corners offer the strength and durability of NO-COAT's SLAM design with a superior aesthetic finish.

Features/Benefits

- Perfect ridgeless radius
- Eliminates transition angles and bead ridges for superior aesthetic result
- Will not dent - handles severe impacts
- SLAM corner design ensures strength & durability



CASED OPENINGS

Standard



EASY-ARCH TRUE ELLIPTICAL ARCHWAY

Optional



Features/Benefits

- All Easy-Arch products are made from high quality, ASTM A653, structural grade 33, hot-dipped galvanized steel (coating designation G40)
- Preformed & precut
- Ready to Install
- Perfect Shapes
- Quick & Easy

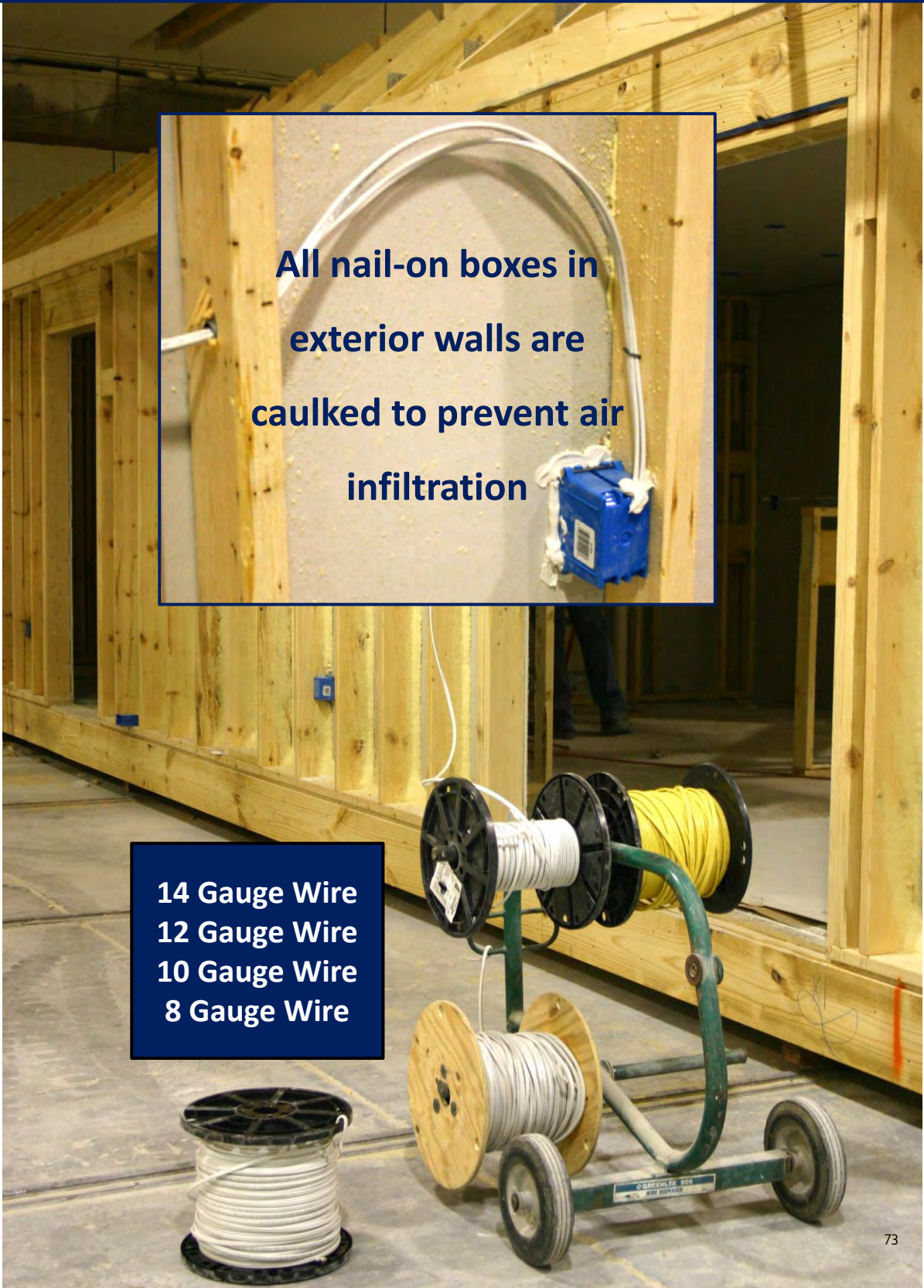

All nail-on boxes in exterior walls are caulked to prevent air infiltration

**14 Gauge Wire
12 Gauge Wire
10 Gauge Wire
8 Gauge Wire**

WALL-HUNG TV BLOCKING

Optional



BEFORE

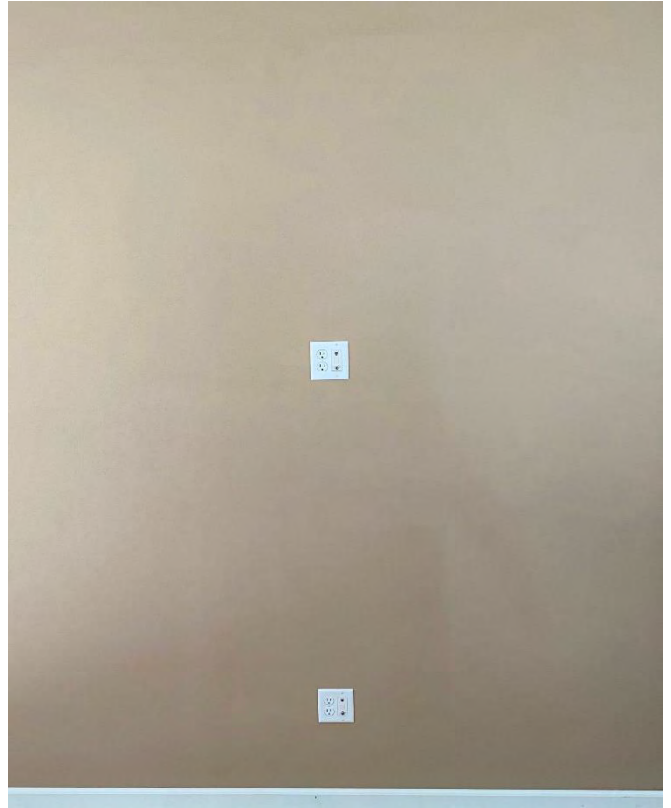

AFTER

HI/LOW COMMUNICATION BOXES & HDMI CABLE CONDUIT

LED LIGHT

Standard (See Spec Sheet for Locations)



- Off-board driver minimizes installation height & maximizes fixture life through improved heat management
- Dimmable to less than 5% with compatible TRIAC dimmers
- Operating temperature of 0° to 120°F (-18°C to 49°C)
- Input voltage of 120VAC
- TM-21 Reported L70(9K) hours >54,000



BEDROOM, LOFT or STUDY LIGHTS

Standard

Optional in the Living/Family Room

BULB INCLUDED



**SATIN NICKEL
563SN**



**FLAT BLACK
563FTB**



**BRONZE
563BZ**

ENTRY FOYER, BEDROOM, STUDY, LIVING/FAMILY ROOM LIGHTS

Optional

BULBS NOT INCLUDED



**SEMI-FLUSH SATIN NICKEL
575SN**



**SEMI-FLUSH BRONZE
575BZ**



**SATIN NICKEL
2152SN**



**BRUSHED BRONZE
2152BRZ**

**ENTRY FOYER, BEDROOM, STUDY, LIVING/FAMILY ROOM
LIGHTS**

Optional

BULBS NOT INCLUDED



**BURBANK MATTE BLACK
163MB**

ENTRY FOYER LIGHTS

Optional

BULBS NOT INCLUDED



SATIN NICKEL
3234SN



RUBBED BRONZE
3234RBZ



MATTE BLACK
3234MB

ENTRY FOYER LIGHTS

Optional

BULBS NOT INCLUDED



**RUBBED BRONZE
3230RBZ**



**ANTIQUE SILVER
3230AS**

ENTRY FOYER & FORMAL DINING LIGHTS

Optional

BULBS NOT INCLUDED



**NATALIE SATIN NICKEL
1463SN**



**BRISTO SATIN NICKEL
7253SN**



**CIMMARON SATIN NICKEL ⁸¹
2153SN**

ENTRY FOYER & FORMAL DINING LIGHTS

Optional

BULBS NOT INCLUDED



NATALIE RUBBED BRONZE
1463RBZ



BRISTO RUBBED BRONZE
7253RBZ



CIMMARON RUBBED BRONZE
2153RBZ

ENTRY FOYER & FORMAL DINING LIGHTS

Optional

BULBS NOT INCLUDED



**MAIN STREET SATIN NICKEL
75SN**



**MAIN STREET MATTE BLACK
75BK**



**BURBANK MATTE BLACK
143MB**



**CLIFTON MATTE BLACK/BRUSHED NICKEL
3503MB/BN**

ENTRY FOYER & FORMAL DINING LIGHTS

Optional

BULBS NOT INCLUDED



NATALIE SATIN NICKEL
1465SN



BRISTO SATIN NICKEL
7255SN



CIMMARON SATIN NICKEL 84
2155SN

ENTRY FOYER & FORMAL DINING LIGHTS

Optional

BULBS NOT INCLUDED



NATALIE RUBBED BRONZE
1465HBZ



BRISTO RUBBED BRONZE
7255RBZ



CIMMARON RUBBED BRONZE
2155RBZ

ENTRY FOYER & FORMAL DINING LIGHTS

Optional

BULBS NOT INCLUDED



**BURBANK MATTE BLACK
145MB**



**CLIFTON MATTE BLACK & BRUSHED NICKEL
3505MB/BN**

SCONCES - Loft & 2nd Floor Hall

Optional

BULB INCLUDED

**LANSING
RUBBED BRONZE
3071RBZ**



**LANSING
BRUSHED PEWTER
3071BPW**



**CIMMARON
RUBBED BRONZE
2161RBZ**



**CIMMARON
SATIN NICKEL
2161SN**



**NATALIE
RUBBED BRONZE
1491RBZ**



**NATALIE
SATIN NICKEL
1491SN**



SCONCES - Loft & 2nd Floor Hall

BULB INCLUDED

Optional



**BURBANK MATTE BLACK
171MB**

ELECTRIC PANEL – 200 Amp Standard

All homes feature copper wire ONLY. Wired to meet or exceed current national electrical code requirements.



Model A40408B1200
White

USB CHARGING STATION, COMMUNICATION OUTLETS

Standard

**One Charger is
Standard in All Homes.
Additional Chargers
are optional.**



Communication Outlet for Cable & Phone Standard

2 each in the Master Bedroom
& Living Room.

One TV Jack is Standard in
Remaining Bedrooms.

Standard Overlay ½”

Standard Overlay doors and drawer fronts are designed with a back beveled profile to eliminate the need for decorative hardware; however it is recommended for additional finish longevity.



SOL shown in Clayton Maple Frappe



FOL shown in Henning Maple Frappe

Full Overlay 1 ¼”

Optional Decorative Hardware is required with Full Overlay styles

CLAYTON OAK CABINETS
Standard



CLAYTON (SOL)
Shown in Oak Walnut Stain

CABINETS

Optional Door Styles



FREEMONT (SOL)

Shown in Oak Walnut



HENNING (FOL)

Shown in Maple Smoke



EVELYN (FOL)

Shown in Cherry Pecan



**CLAYTON
RAISED PANEL**
Available in

Oak
Maple
Cherry



**EVELYN
BEADED CENTER PANEL**
Available in

Oak
Maple
Knotty Alder
Hickory
Cherry



**FREEMONT
FLAT PANEL**
Available in

Oak
Maple



**HENNING
FLAT PANEL**
Available in

Oak
Maple
Knotty Alder
Hickory
Cherry

CABINETS
Optional Oak



HENNING (FOL)

Shown in Oak Peppercorn Stain

CABINETS

Optional Maple



FREMONT (SOL)

Shown in Maple Onyx Stain

CABINETS

Optional Hickory



EVELYN (FOL)

Shown in Hickory Natural Stain

CABINETRY

Optional Knotty Alder



HENNING (FOL)

Shown in Knotty Alder Pecan Stain

CABINETS

Optional Cherry



CLAYTON (SOL)

Shown in Cherry Espresso Stain

CABINETS

Optional Sheer Stained Oak Cabinets

Coastal Collection

This finish process consists of a semi-transparent pigmented stain evenly applied to all finished components resulting in a color washed finish with slight visibility to the wood character and tone. Pigmented stains are semi-transparent; meaning the wood color and texture will affect the overall finish and will be slightly apparent. The texture of wood species with open grain, such as oak, will be more apparent compared to the closed grain character of maple. A satin finish oven-cured top-coat completes the process and provides a superior sealed product.



FREEMONT OAK (SOL)

Shown in Oak Castle Rock Sheer Stain

CABINETS

Optional Painted Maple



HENNING (FOL)

Shown in Maple Gale Paint

WOOD CHARACTERISTICS

OAK

MINERAL
STREAKS

ARCHED
GRAIN

MINERAL
STREAKS

UNIFORM
GRAIN

MAPLE

MINERAL
STREAKS

BURL

SESAME

TRACKING
MAPLE

KNOTTY
ALDER

CHECKING

CLOSED
KNOT

MINERAL
STREAKS

OPEN
KNOT

HICKORY

BURL

KNOT

MINERAL
STREAKS

PIN KNOT

CHERRY

MINERAL

PITCH

SAP
WOOD

PIN KNOT

OAK STAIN SELECTIONS

Standard



SANDALWOOD

PECAN

WALNUT

OAK STAIN SELECTIONS

Standard



PEPPERCORN

EAGLE ROCK

SMOKE

MAPLE STAIN SELECTIONS

Optional



GINGERSNAP



EAGLE ROCK



SMOKE



ONYX

KNOTTY ALDER STAIN SELECTIONS

Optional



NATURAL



HAZELNUT



CHESTNUT



SMOKE

HICKORY STAIN SELECTIONS

Optional



NATURAL



SANDALWOOD



PECAN



SMOKE

CHERRY STAIN SELECTIONS

Optional



PECAN



BRANDYWINE



ESPRESSO

CHERRY STAIN SELECTIONS

Optional

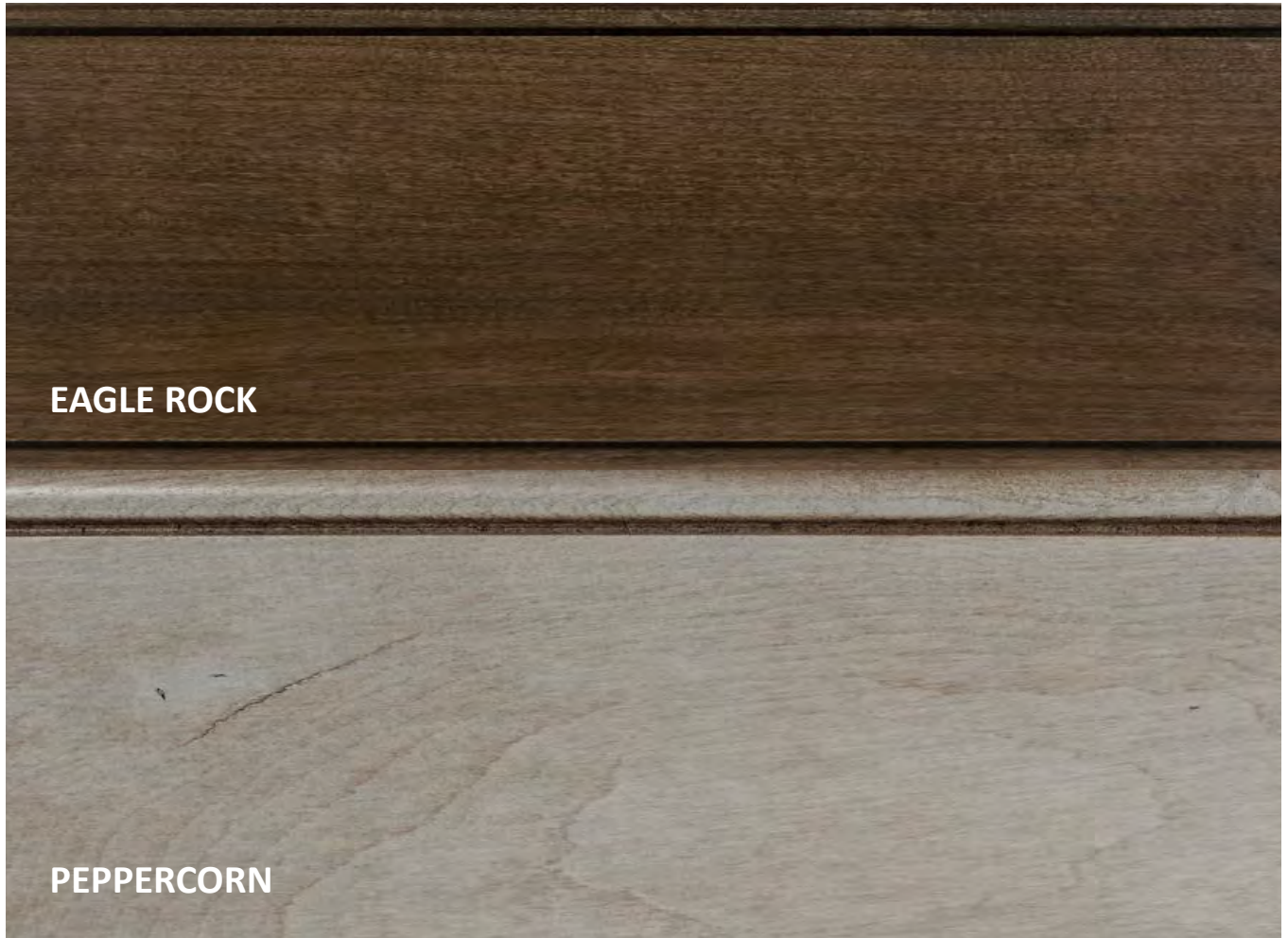

EAGLE ROCK

PEPPERCORN

OAK SHEER STAIN SELECTIONS

Optional



CASTLE ROCK SHEER

COTTAGE WHITE SHEER

MAPLE PAINT SELECTIONS

Optional

MACCHIATO

FRAPPE

EARL GREY

MAPLE PAINT SELECTIONS

Optional

WHITE ICING

SEA SALT

GALE

CARRIAGE BLACK

TRADITIONAL MULLION DOORS

Optional

Traditional Mullions

- Solid dividers and clear glass
- Clear glass insert is safety glass (laminated or tempered)
- Clear glass may be replaced with textured glass
- NOTE: Shelves may not align with decorative mullion grid detail.

Matching Interior Finish

- Cabinets with glass inserts include plywood construction (veneered in species indicated on order)
- Components upgraded to plywood include: interior, end panels, tops, bottoms, backs and shelving stained or painted to match the exterior color of the cabinet



PRAIRIE MULLION DOORS

Optional in Evelyn & Henning Doors ONLY

Prairie Mullions

- Solid dividers and clear glass
- Clear glass insert is safety glass (laminated or tempered)
- Clear glass may be replaced with textured glass
- Shelves may not align with decorative mullion grid detail
- **Available in Evelyn & Henning ONLY**

Matching Interior Finish

- Cabinets with glass inserts include plywood construction (veneered in species indicated on order)
- Components upgraded to plywood include: interior, end panels, tops, bottoms, backs and shelving stained or painted to match the exterior color of the cabinet



SEEDY GLASS DOORS

Optional

Seedy Glass Inserts

- Antiqued, speckled pattern
- Slightly obscure
- Textured safety glass (laminated or tempered) installed into frame
- Smooth side of glass is facing out, may be reversed in field
- Please view samples of decorative glass for proper representation

Matching Interior Finish

- Cabinets with glass inserts include plywood construction (veneered in species indicated on order)
- Components upgraded to plywood include: interior, end panels, tops, bottoms, backs and shelving stained or painted to match the exterior color of the cabinet



WATER GLASS DOORS

Optional

Water Glass Inserts

- Subtle wave pattern
- Mostly clear
- Textured safety glass (laminated or tempered) installed into frame
- Smooth side of glass is facing out, may be reversed in field
- Please view samples of decorative glass for proper representation

Matching Interior Finish

- Cabinets with glass inserts include plywood construction (veneered in species indicated on order)
- Components upgraded to plywood include: interior, end panels, tops, bottoms, backs and shelving stained or painted to match the exterior color of the cabinet



CLEAR GLASS DOORS

Optional

Clear Glass Inserts

- Textured safety glass (laminated or tempered) installed into framed side of glass is facing out, may be reversed in field
- Please view samples of decorative glass for proper representation

Matching Interior Finish

- Cabinets with glass inserts include plywood construction (veneered in species indicated on order)
- Components upgraded to plywood include: interior, end panels, tops, bottoms, backs and shelving stained or painted to match the exterior color of the cabinet



KITCHEN CABINET COMPANIES AREN'T ALL THE SAME. MAKE SURE YOU PICK ONE THAT HAS A POSITIVE IMPACT ON THE ENVIRONMENT.

A recent study by Hanley-Wood found that environmental sustainability is one of the top reasons cited when selecting cabinets



KITCHEN CABINET MANUFACTURERS ASSOCIATION
ENVIRONMENTAL STEWARDSHIP PROGRAM (ESP)
ALL PRODUCTS IMPACT THE ENVIRONMENT
FOR ESP PROGRAM CRITERIA, VISIT KCMA.ORG

RESPONSIBLE PROCESS RESOURCE MANAGEMENT:

Cabinet manufacturers are checked to ensure they are dealing with wastes in responsible, sustainable ways and that they have a comprehensive recycling program in place.



ENVIRONMENTAL STEWARDSHIP:

Cabinet manufacturers are checked to ensure they have a written policy stating their commitment to environmental quality and that they attempt to ensure their vendors also engage in environmentally sustainable practices.



To earn the KCMA Environmental Stewardship Program Certification Seal, companies need to score 80 out of a possible 110 points in these categories:

COMMUNITY ENGAGEMENT:

Cabinet manufacturers are examined to ensure they demonstrate community involvement and observe all federal, state and local environmental regulations.

SUSTAINABLE PRODUCT RESOURCE MANAGEMENT:

Cabinet manufacturers are investigated to ensure they are purchasing materials from reputable companies with sustainable forestry programs.



AIR QUALITY:

Cabinets are inspected to ensure they meet safe emission standards for formaldehyde and other hazardous air pollutant levels.

For a full list of requirements and to learn more about how you can become ESP Certified, visit our website at www.kcma.org.

Yorktowne

A LOT OF KITCHEN CABINETS LOOK ALIKE, HOW DO YOU PICK ONE YOU CAN TRUST?

This Old House says you shouldn't buy a cabinet without the KCMA Certified Seal



ANSI/KCMA A161.1

DRAWER:

We load drawers at 15 pounds per square foot and operate them through 25,000 cycles, representing 20 years of regular use.



DOOR:

We load a cabinet door with 65 pounds, cycle through open and close ten times and inspect for visible signs of looseness.



Why?

To earn the KCMA Certified Seal, kitchen cabinets must be put through a series of 15 tests. During these tests, cabinets are checked for structural strength and finish quality. The cabinet boxes as well as drawers and doors are tested throughout the process.

STRUCTURAL:

We load wall-mounted cabinets to 600 pounds and look for structural failure. These tests verify the integrity and strength of the cabinets.



FINISH:

We expose the finish to vinegar; lemon, orange and grape juices; tomato ketchup; coffee; olive oil; 100-proof alcohol; mustard; and to long periods of exposure to a detergent and water solution.



The KCMA A161.1 Quality Certification Seal makes it easy to recommend cabinets. In fact, this seal is so trusted, *This Old House* recommends only buying cabinets with the KCMA A161.1 Quality Certification Seal.

Make sure your cabinets are recommended. Get certified today!

For more information visit the website www.kcma.org/certifications/about

Yorktowne

CABINETS
Optional



**OPTIONAL
TILT-DOWN TRAY**



**OPTIONAL
DOUBLE PULL-OUT WASTE CONTAINER**

CABINETS
Optional



**OPTIONAL
PULL-OUT SHELVES**



3-DRAWER STACK
One Standard in Every Kitchen

CABINETRY
Optional



PANTRY



OVEN CABINET



KANE CABINET KNOBS & PULLS

Optional



**SATIN NICKEL
BP53702G10**



**OIL-RUBBED BRONZE
BP53702ORB**



**CHAMPAGNE BRONZE
BP53702BBZ**



**BLACK BRONZE
BP53702BBR**

**SATIN NICKEL
BP53700G10**



**OIL-RUBBED BRONZE
BP53700ORB**



**CHAMPAGNE BRONZE
BP53700BBZ**



**BLACK-BRONZE
BP53700BBR**



CANDLER CABINET KNOBS & PULLS

Optional

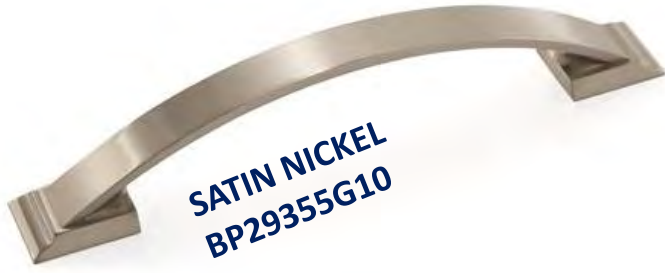

**SATIN NICKEL
BP29355G10**



**SATIN NICKEL
BP29340G10**



**OIL-RUBBED BRONZE
BP29355ORB**



**OIL-RUBBED BRONZE
BP29340ORB**



**CHAMPAGNE BRONZE
BP29355BBZ**



**CHAMPAGNE BRONZE
BP29340BBZ**



**BLACK BRONZE
BP29355BBR**



**BLACK-BRONZE
BP29340BBR**

MODERN CABINET KNOBS & PULLS

Optional



SATIN NICKEL
5001-96-SS



SATIN NICKEL
5002-T-SS



OIL-RUBBED BRONZE
BP40516ORB



OIL-RUBBED BRONZE
BP19009ORB



CHAMPAGNE BRONZE
BP40516BBZ



CHAMPAGNE BRONZE
BP19009BBZ



BLACK BRONZE
BP40516BBR



BLACK-BRONZE
BP19009BBR

3X6 SUBWAY TILE BACKSPLASH

Optional

Standard Edging is Aluminum L-Shaped Trim See [Page 263](#)
Bullnose Available Upon Request



100 WHITE
With Bright White Grout

101 BISCUIT
With Navajo White Grout

500 WARM GRAY
With Silver Grout ¹²⁷

MINI-SUBWAY TILE BACKSPLASH

Optional

Standard Edging is Aluminum L-Shaped Trim See [Page 263](#)
Bullnose Available Upon Request



100 WHITE
With Bright White Grout

101 BISCUIT
With Navajo White Grout

500 WARM GRAY
With Silver Grout¹²⁸

COLLINS® KITCHEN FAUCET
Standard

4-HOLE MOUNT



CHROME
440-DST

COLLINS® KITCHEN FAUCET
Optional

4-HOLE MOUNT



STAINLESS STEEL
440-SS-DST

LELAND® KITCHEN FAUCET W/PULL SPOUT

1 OR 3-HOLE MOUNT

Optional (specify with or without escutcheon plate)



ARCTIC STAINLESS
9178-AR-DST



VENETIAN BRONZE
9178-RB-DST

ShieldSpray® Technology

POWERS OFF THE MESS WITHOUT MAKING A MESS.



ShieldSpray® Technology makes faucets more versatile than ever.

- Concentrated jet of water powers away stubborn messes.
- Innovative protective sphere of water contains the splatter.
- Activate by pulling down the wand, then pressing and holding the top button on the spray.

For more information, visit deltafaucet.com/shieldspray



ESSA® KITCHEN FAUCET with Pull Spout

1 OR 3-HOLE MOUNT

Optional (specify with or without escutcheon plate)



**STAINLESS STEEL
9113-SS-DST**



**MATTE BLACK
9113-BL-DST**



**VENETIAN BRONZE
9113-RB-DST**



TRINSIC® KITCHEN FAUCET with Pull Spout
Optional

1-HOLE MOUNT



BLACK STAINLESS STEEL
9159-KS-DST

TRINSIC® KITCHEN FAUCET with Pull Spout

1-HOLE MOUNT

Optional



CHROME
9159-DST



STAINLESS STEEL
9159-SS-DST



MATTE BLACK
9159-BL-DST



CHAMPAGNE BRONZE
9159-CZ-DST¹³⁵

BASKET STRAINER/DISPOSER FLANGE (2)

Optional

BRUSHED STAINLESS STEEL



OIL-RUBBED BRONZE



MATCHING STRAINERS/DISPOSER FLANGES AVAILABLE PER CUSTOM QUOTE
Shown in Black

ELKAY



FORMICA SURFACE MOUNT SINK

Standard



**4-HOLE STAINLESS STEEL
DOUBLE EQUAL BOWL
DSE233224**

FORMICA SURFACE MOUNT SINK

Optional



*American
Standard*

**STAINLESS STEEL
SINGLE BOWL
18SB.933221.075**

Optional 1,3 HOLE



KOHLER®

**HARTLAND WHITE
ENAMELED CAST IRON
DOUBLE EQUAL BOWL
K-5818**

Optional 1,3,4-HOLE

FORMICA UNDERMOUNT SINK

Optional



**STAINLESS STEEL
DOUBLE EQUAL BOWL
E-350**

Standard Option

**STAINLESS STEEL
DOUBLE EQUAL BOWL
E-550**

Optional

**STAINLESS STEEL
SINGLE BOWL
E-540**

Optional

FORMICA UNDERMOUNT SINK

Optional



**QUARTZ
DOUBLE EQUAL BOWL
Q-350**

Standard Option
Shown in Black



**QUARTZ
SINGLE BOWL
Q-340**

Optional
Shown In Black



Matching Strainers & Disposer
Flanges Available per Custom Quote



BLACK



GREY



CONCRETE



WHITE



BISQUE



BROWN

FORMICA APRON SINK

Optional



**JOSEPHINE FIRECLAY
3-HOLE WHITE
SK450-34FC**

FORMICA COUNTERTOPS

Standard

BUTTERUM GRANITE
7732-58



GIALLO GRANITE
3523-46



NATURAL CANVAS
7022-58

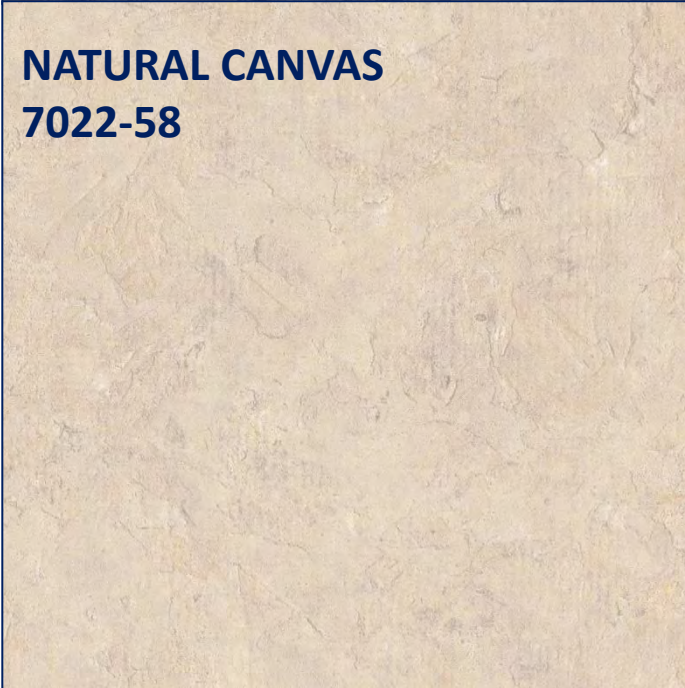

BELMONTE GRANITE
3496-58



FORMICA COUNTERTOPS

Standard

JAMOCHA GRANITE

7734-58

PERLATO GRANITE

3522-46

ELEMENTAL CONCRETE

8830-58

ARGENTO ROMANO

6697-58

FORMICA COUNTERTOPS

Standard

BASALT SLATE
3690-58

WHITE ICE GRANITE
9476-58



FORMICA COUNTERTOPS – 180FX

Optional

A rectangular sample of a Formica countertop with a light beige and cream-colored marbled pattern, featuring subtle brown and tan veining.

CREMA MASCARELLO
3422FX-RD

A rectangular sample of a Formica countertop with a grey and white marbled pattern, featuring darker grey and black veining, resembling a granite texture.

CLASSIC CRYSTAL GRANITE
9284FX-RD

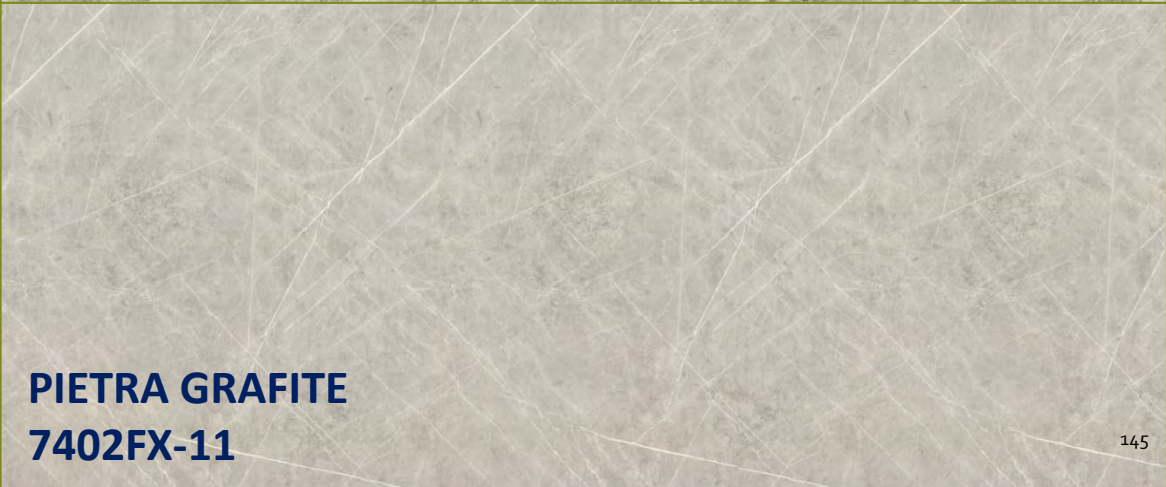
A rectangular sample of a Formica countertop with a light grey background and a network of thin, white, vein-like lines, resembling a marble or stone pattern.

PIETRA GRAFITE
7402FX-11

FORMICA COUNTERTOPS – 180FX

Optional



FORMICA COUNTERTOPS – 180FX

Optional

A close-up photograph of a countertop with a complex, organic pattern of brown, tan, and grey tones, resembling natural stone or a high-quality laminate.

GOLDEN MASCARELLO
3465FX-RD

A close-up photograph of a countertop with a complex, organic pattern of brown, tan, and grey tones, similar to the Golden Mascarello but with a slightly different texture and color distribution.

ANTIQUE MASCARELLO
3466FX-RD

A close-up photograph of a countertop with a dramatic, layered pattern of dark grey, black, and light grey tones, creating a sense of depth and movement.

DOLCE VITA
3420FX-46

147

FORMICA COUNTERTOP EDGE PROFILES

STANDARD E-TOP 2000 EDGE

The 90°/90° oval, flat-front roll nose complements today's cabinets creating a luxurious look. The laminate wraps around the front nose giving added protection. More curves, softer flowing lines, just the right touches.

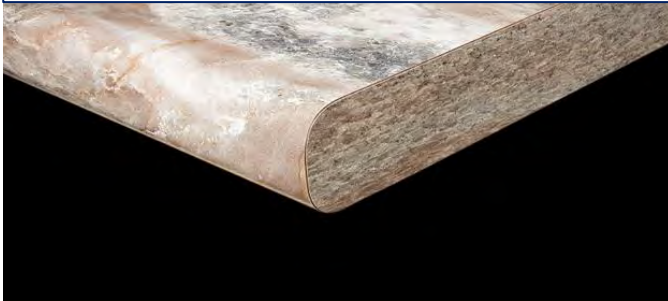

OPTIONAL AMORE' EDGE

This beautiful profile gives a classic edge to your kitchen or bath that emulates the luxurious look of stone. Shown with flat cap. Available with profile edge.

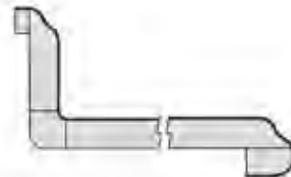

OPTIONAL AEGEAN EDGE

The Aegean gives you a sleek, eased edge without the black line common to many laminate countertops. Shown with flat cap. Available with profile edge.

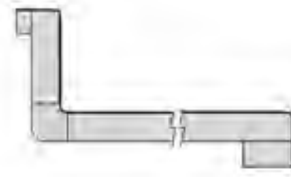

AMORE' TOP
with PROFILE EDGE



AEGEAN TOP
with PROFILE EDGE



DOLCE VITA
3420FX-46

**When selecting a Formica top, please be aware that some of
the more linear patterns may not match up at the seams**

SOLID SURFACE INTEGRATED SINK

Optional



**SOLID SURFACE
DOUBLE EQUAL BOWL**
Standard Option
Shown in Ivory White



**SOLID SURFACE
SINGLE BOWL**
Optional
Shown In Arctic White



ARCTIC WHITE



IVORY WHITE

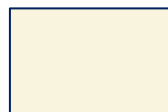

CREAM



ALMOND

SOLID SURFACE COUNTERTOPS Level I

Optional



SOLID SURFACE COUNTERTOPS Level I

Optional



ARCTIC WHITE S006



ARCTIC GRANITE G034



MAUI QUARTZ G223R



WALLOWA G157

SOLID SURFACE COUNTERTOPS Level II

Optional

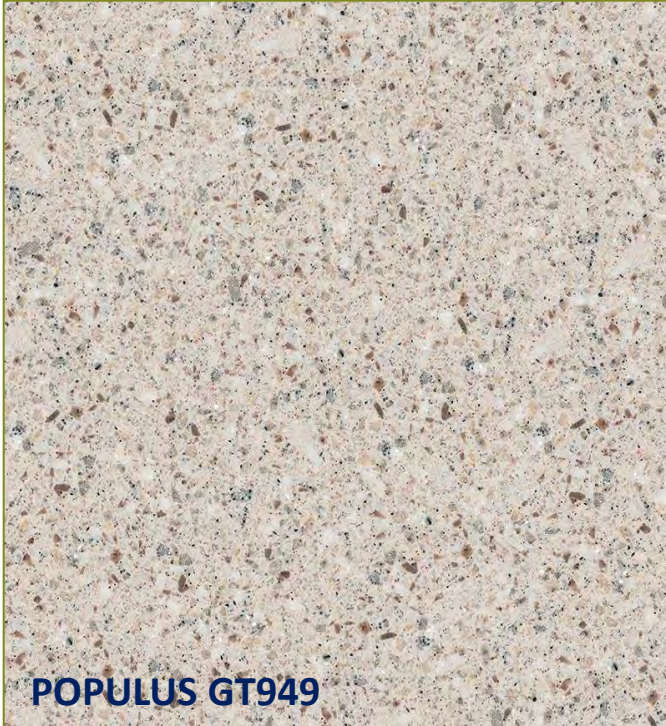

POPULUS GT949

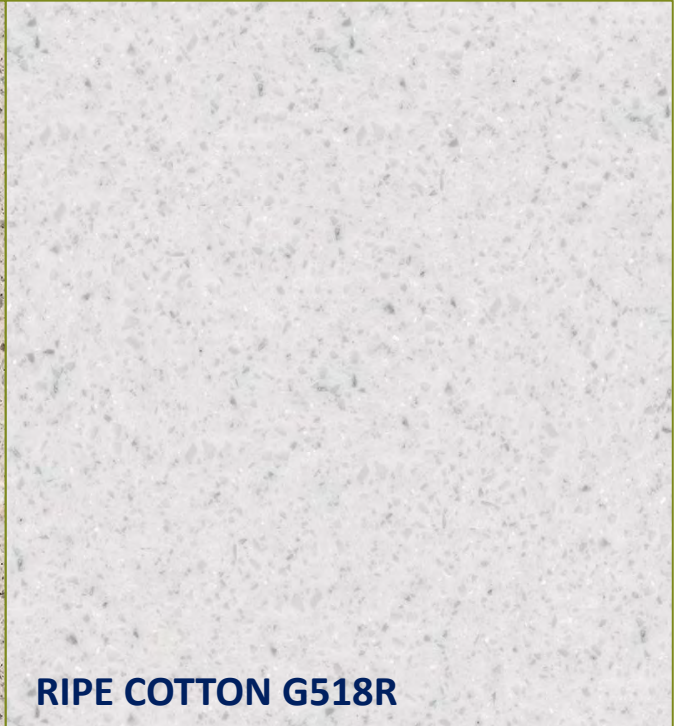

RIPE COTTON G518R

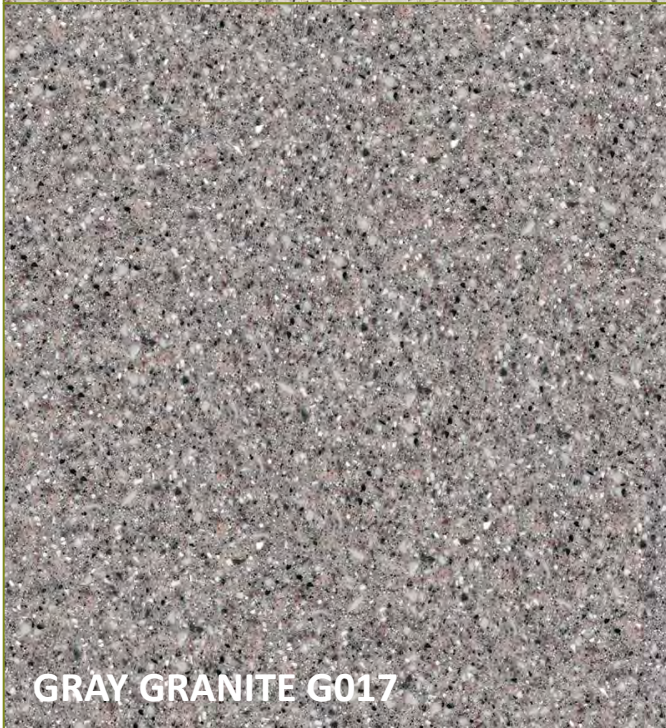

GRAY GRANITE G017

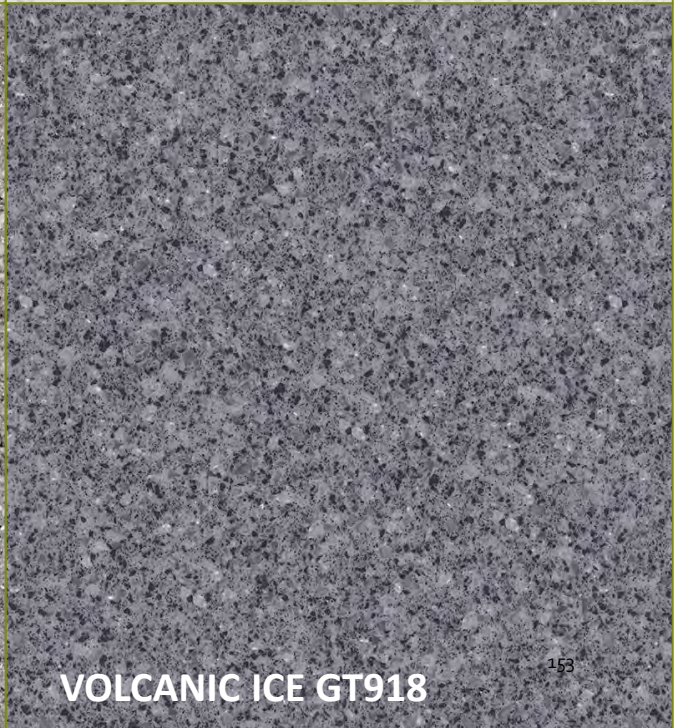

VOLCANIC ICE GT918

SOLID SURFACE COUNTERTOPS Level II

Optional

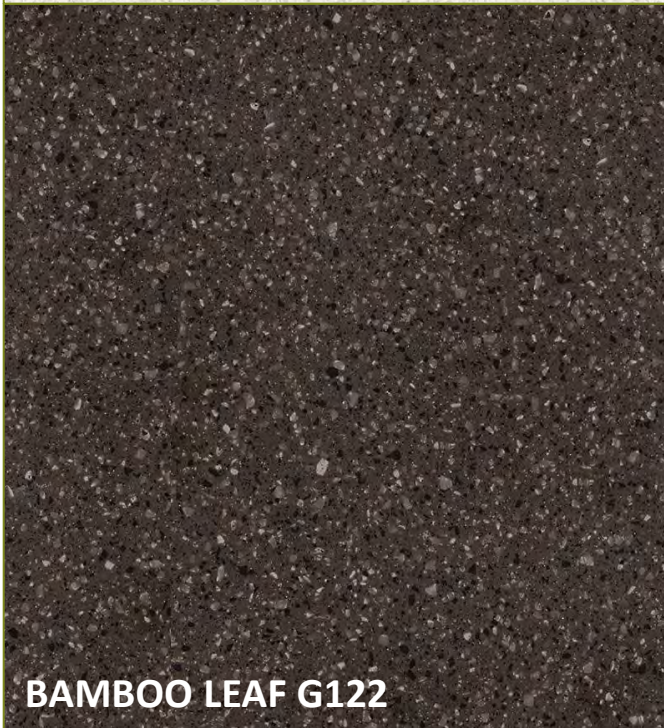
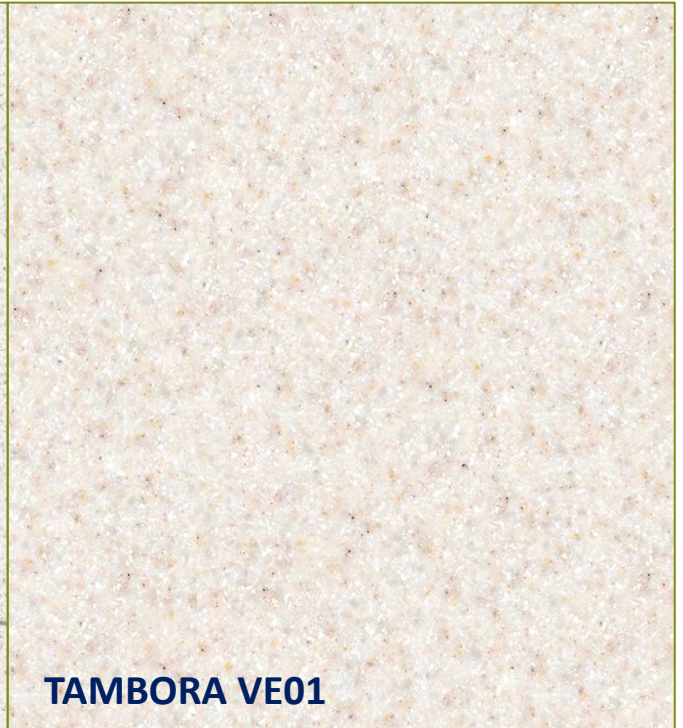
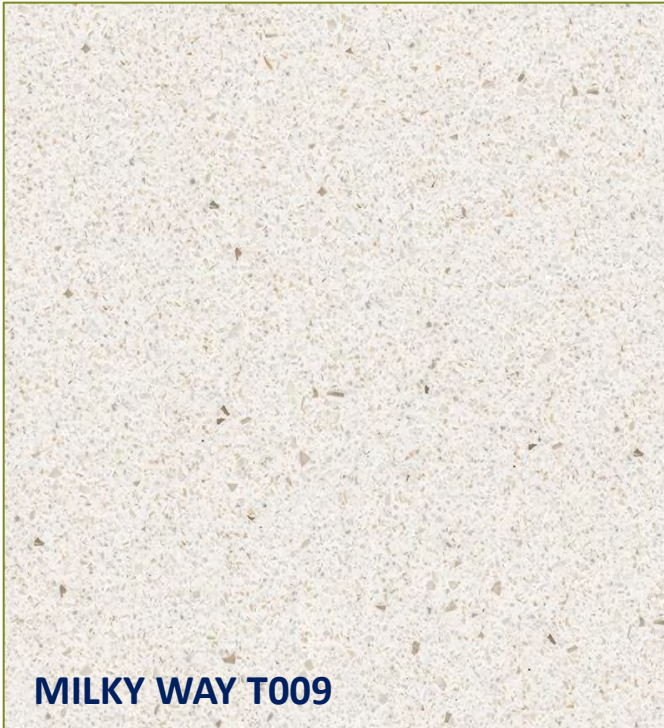

SOLID SURFACE EDGE PROFILES

Standard



EASED (N-2)



ROMAN OGEE (N-9)

GRANITE/QUARTZ UNDERMOUNT SINK
Optional



**STAINLESS STEEL
DOUBLE EQUAL BOWL
MSI-3118**
Optional



**STAINLESS STEEL
SINGLE BOWL
MSI-3018**
Optional

GRANITE/QUARTZ UNDERMOUNT SINK

Optional



**QUARTZ
DOUBLE EQUAL BOWL
ELGU3322**

Optional
Shown in Greige



**QUARTZ
SINGLE BOWL
ELGRU13322**

Optional
Shown in Greige

Matching Strainers & Disposer
Flanges Available per Custom Quote



BLACK



DUSK GRAY

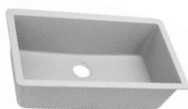

WHITE



PUTTY



GREIGE

¹⁵⁷

GRANITE/QUARTZ APRON SINK*
Optional



**GWEN FIRECLAY
WHITE
FS33**



GRANITE/QUARTZ APRON SINK*

Optional



**CROSTOWN
STAINLESS STEEL
ECTRUF30179R**

GRANITE COUNTERTOPS Level I

Optional



BENGAL WHITE



AZUL PLATINO



WHITE ORNAMENTAL

GRANITE COUNTERTOPS Level II

Optional



QUARTZ COUNTERTOPS Level I

Optional

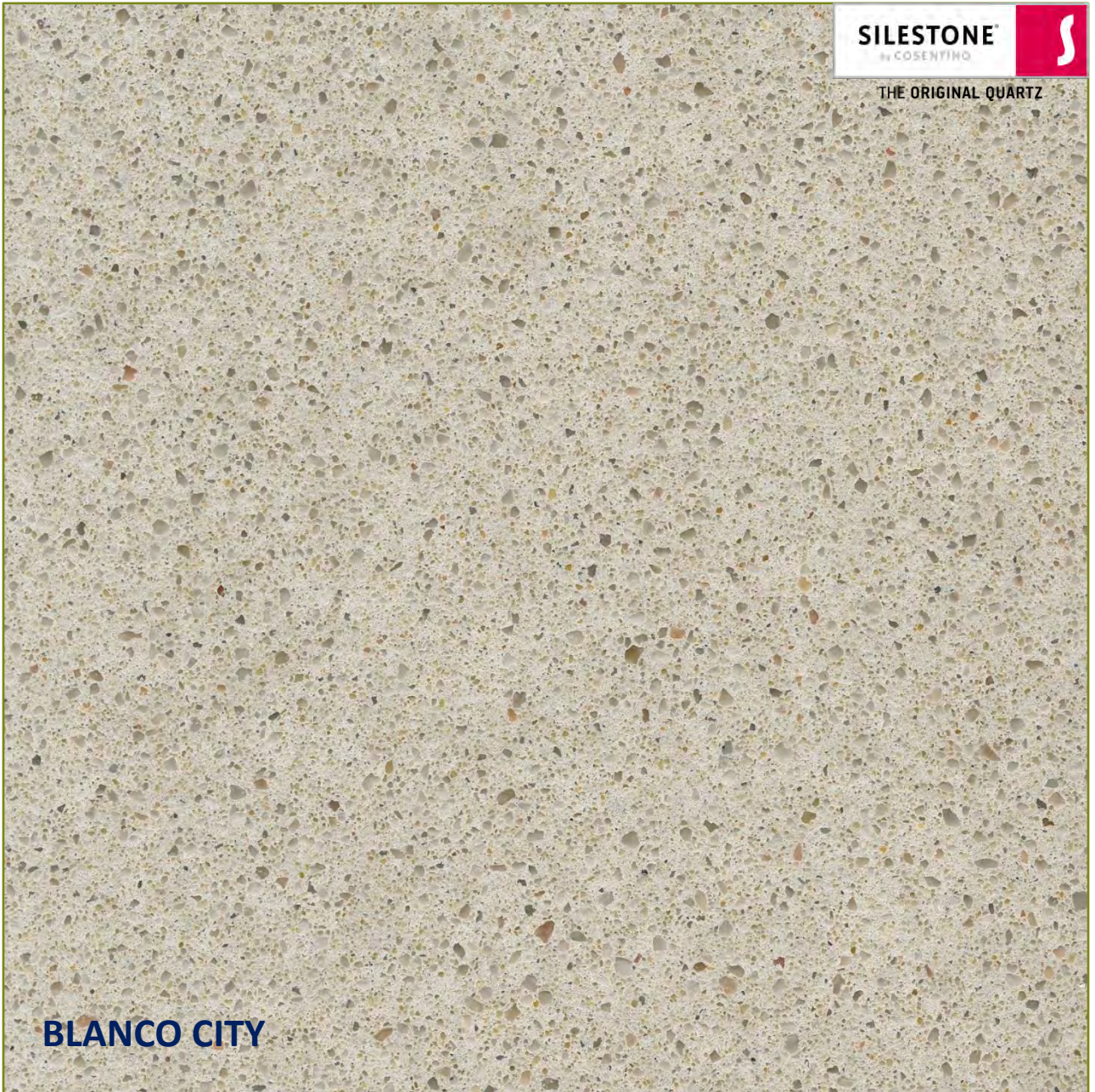

QUARTZ COUNTERTOPS Level I

Optional

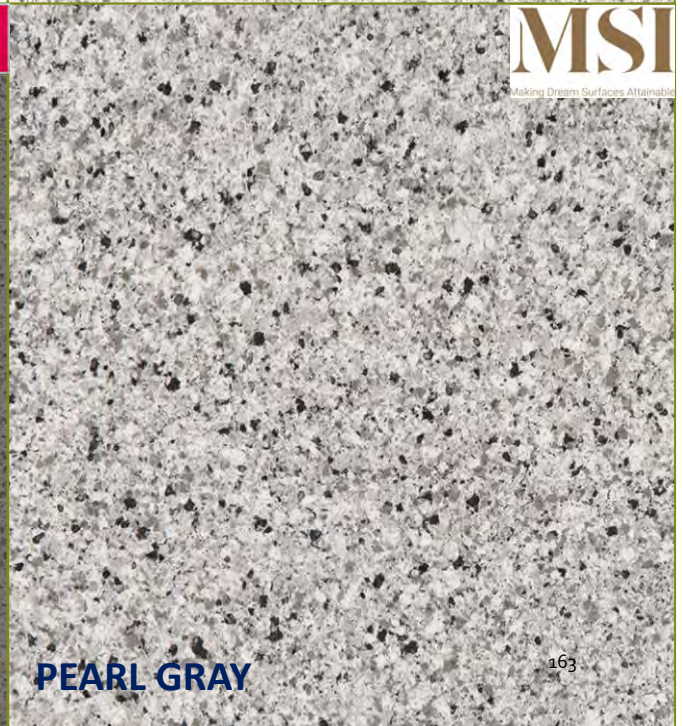
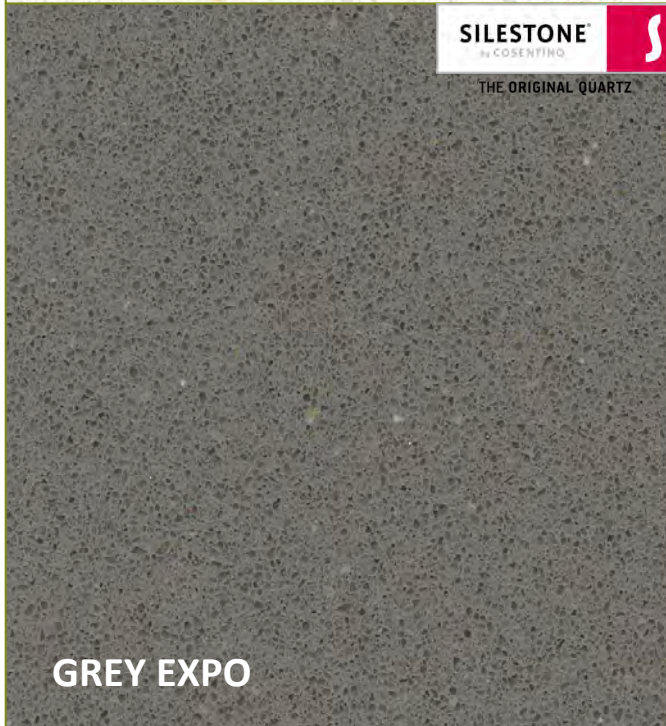
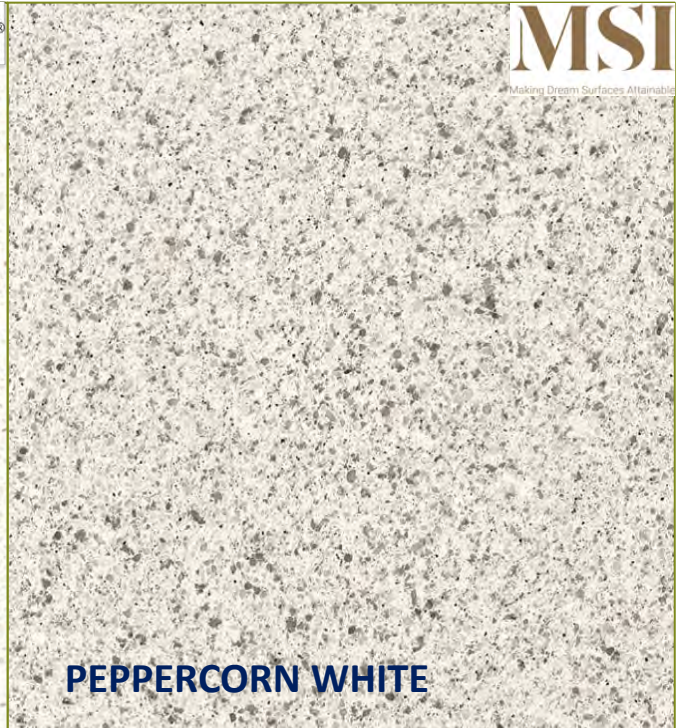
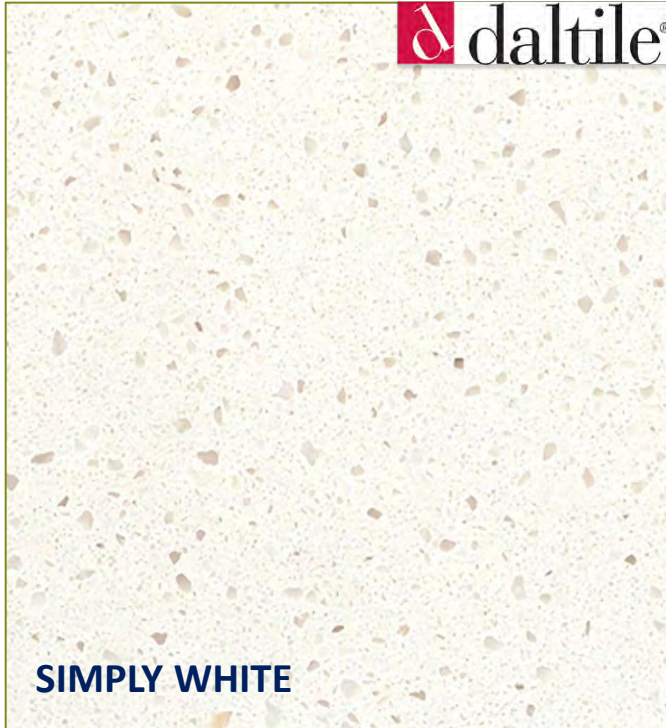

QUARTZ COUNTERTOPS Level II

Optional



NEW CASTILLON

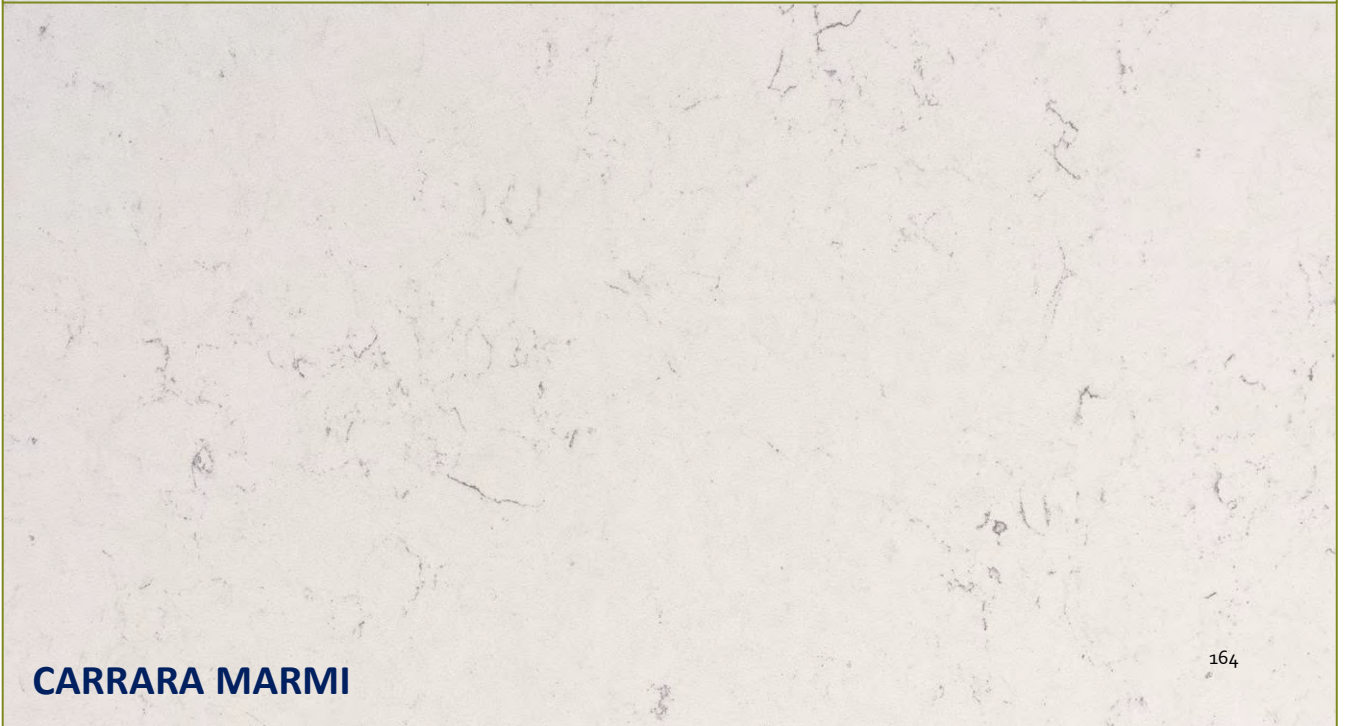

CARRARA MARMI

QUARTZ COUNTERTOPS Level II

Optional



GRANITE & QUARTZ EDGE PROFILES

STANDARD PROFILES



EASED (T)



DOUBLE ROUNDOVER



WATERFALL

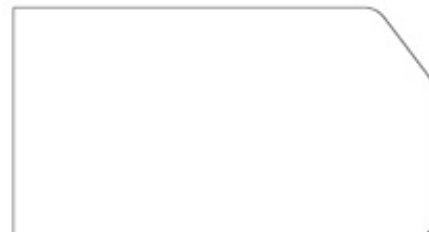

BEVEL

OPTIONAL PROFILES

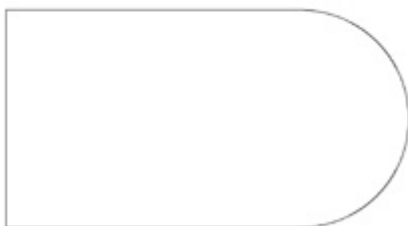

BULLNOSE

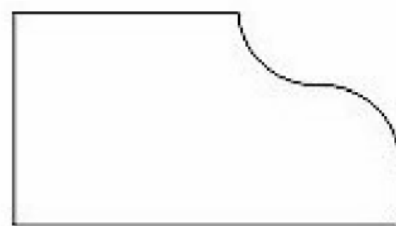

OGEE

LED UNDERCAB LIGHTING with BOTTOM EDGE MOLDING

Optional

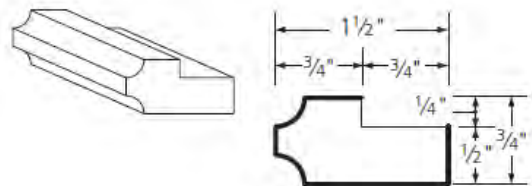

Bottom Edge Molding Matches Cabinet Stain or Paint

- Direct-wire
- White curved frosted lens provides even light distribution
- Slim 1" low profile installs unobtrusively for a streamlined look
- 6-Watt, 300 Lumens output, 50 lm/Watt efficacy, 80 CRI, 3000K color temperature
- LEDs offer 50,000 hours of operating life, never need replacement
- Backed by a 5-year limited manufacturer warranty

SATIN NICKEL PENDANTS

BULB NOT INCLUDED

Optional Pendant Light In Place of LED (Optional)



1701SN



**CIMMARON
2151SN**



**BRISTO
7251SN**



**NATALIE
1461SN**

BRONZE PENDANTS

BULB NOT INCLUDED

Optional Pendant Light In Place of LED (Optional)



BLACK PENDANTS

BULB NOT INCLUDED

Optional Pendant Light In Place of LED (Optional)



170BK



**BURBANK
2151MB**

BROAN® 40000 SERIES UNDER-CABINET RANGE HOOD
Standard



403023
BLACK



403001
WHITE



403002
BISQUE

BROAN® 40000 SERIES UNDER-CABINET RANGE HOOD
Optional



STAINLESS STEEL
403004





VENT HOOD
Optional

STAINLESS STEEL
UVW8301SLSS



← 3" Minimum Clear Space Between Chimney Hood & Wall Cabinets →



Dishwasher Safe Filters

Backlit Controls

LED Dimmable Lights



VENT HOOD

Optional

JVW5301EJES
SLATE



← 3" Minimum Clear Space
Between Chimney Hood
& Wall Cabinets →



JVW5301SJSS
STAINLESS STEEL



JVW5301BJTS
BLACK STAINLESS



JVW5301FJDS
BLACK SLATE¹⁷⁴



1.6 CU FT OVER THE RANGE MICROWAVE with Vent

Optional



STAINLESS STEEL
JVM3162RJSS



BLACK
JVM3162DJBB



WHITE
JVM3162DJWW



DISHWASHER with FRONT CONTROLS

Optional

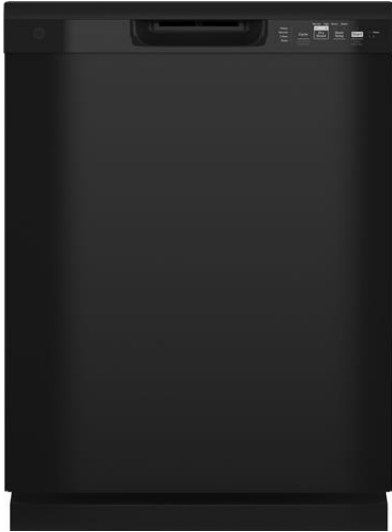

BLACK
GDF510PGRBB



WHITE
GDF510PGRWW



STAINLESS STEEL
GDF510PSRSS

KITCHEN DISPOSAL

Optional



Features

- 1/2 Horsepower Dura-Drive® Induction Motor
- Galvanized Steel Construction
- Assembled in USA with American Pride
- Quick Lock® Sink Mount allows for easy installation and disposer replacement

ICE MAKER HOOK-UP FOR REFRIDGERATOR

Optional



**I2K ICEMAKER BOX
(LEAD FREE)
39136**

VANITY SINK - TOP-MOUNT for FORMICA
Standard

Formica Tops Standard
See Selections on
[Pages 142-149](#)



BISCUIT
Optional

MAVERICK I
3-HOLE, 4" SPREAD
249-4



VANITY SINK - TOP-MOUNT OPTION for FORMICA

Optional

Formica Tops Standard
See Selections on
Pages 142-149

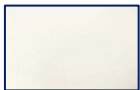

BISCUIT

Optional

**BARRETT
3-HOLE WHITE, 4" SPREAD
268-4**





MAVERICK I



BARRETT

VANITY SINK - UNDERMOUNT OPTION for FORMICA

Optional

Formica Tops Standard
See Selections on
Pages 142-149



**ACRYLIC SINK WHITE
A-306**



VANITY SINK – INTEGRATED OPTION for SOLID SURFACE

Optional

See Solid Surface Tops
Selections on
[Pages 151-155](#)



SINGLE VANITY 1914
Shown in Arctic White



ARCTIC WHITE



IVORY WHITE

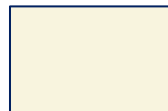

CREAM



ALMOND

**VANITY SINK - UNDERMOUNT OPTION
for GRANITE/QUARTZ**
Optional



BISCUIT

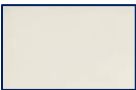

BISCUIT

See Granite & Quartz Tops
Selections on
Pages 160-166

**PORCELAIN
OVAL BOWL
1714**

Shown in White

**PORCELAIN
WAVE BOWL
1813**

Shown in White

MARBLE VANITY TOPS

Optional

Formica Tops Standard
See Selections on
Pages 142-149



WAVE BOWL
Shown in White on White



OVAL BOWL
Shown in Pebble Creek

MARBLE VANITY TOP COLOR SELECTIONS

Optional



ANTIQUÉ WHITE
MR03



STERLING GRAY
MR09



WHITE ON WHITE
MR02



PEBBLE CREEK
GR108



CLOUD
GR115



BLIZZARD
GR107

CLASSIC® LAVATORY FAUCET
Standard



CHROME
520-DST



CLASSIC® LAVATORY FAUCET
Optional



STAINLESS STEEL
520-SS-DST

WOODHURST® LAVATORY FAUCETS

Optional



STAINLESS STEEL
3532LF-SSMPU



VENETIAN BRONZE
3532LF-RBMPU

LAHARA® LAVATORY FAUCETS

Optional



TRINSIC® LAVATORY FAUCETS

Optional (specify with or without escutcheon plate)



STAINLESS STEEL
559LF-SSMPU



MATTE BLACK
559LF-BLMPU



CHAMPAGNE BRONZE
559LF-CZMPU



VENETIAN BRONZE
559LF-RBMPU

CLASSIC MONITOR® TUB & SHOWER TRIM Standard



**CHROME
T13420**

CLASSIC MONITOR® TUB & SHOWER TRIM

Optional



STAINLESS STEEL
T13420-SS

WOODHURST® TUB & SHOWER TRIM

Optional



STAINLESS STEEL
T14432-SS



VENETIAN BRONZE
T14432-RB



LAHARA® TUB & SHOWER TRIM

Optional



CHROME
T14438



STAINLESS STEEL
T14438-SS



LAHARA® TUB & SHOWER TRIM

Optional



CHAMPAGNE BRONZE
T14438-CZ



VENETIAN BRONZE
T14438-RB





TOUCH CLEAN[®]

TOUCH CLEAN[®] SPRAY HOLES

Wipe away calcium
and lime build up
with touch of a finger.

TRINSIC® TUB & SHOWER TRIM

Optional



STAINLESS STEEL T14459-SS



VENETIAN BRONZE T14459-RB



TRINSIC® TUB & SHOWER TRIM

Optional



CHAMPAGNE BRONZE
T14459-CZ



MATTE BLACK
T14459-BL





see what Delta can do

H₂OKINETIC[®]
SHOWERS
GIVE YOU
MORE

**MORE
COVERAGE**

**MORE
INTENSITY**

**MORE
WARMTH**

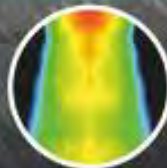
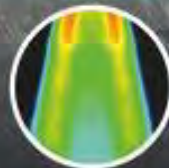

Standard Shower

H₂Ok kinetic[®] Shower

Standard Shower

H₂Ok kinetic[®] Shower

Standard Shower

H₂Ok kinetic[®] Shower

CLASSIC MONITOR® SHOWER TRIM Standard



**CHROME
T13220**



CLASSIC MONITOR® SHOWER TRIM

Optional



STAINLESS STEEL
T13220-SS

WOODHURST® SHOWER TRIM

Optional



STAINLESS STEEL
T14232-SS



VENETIAN BRONZE
T14232-RB



LAHARA® SHOWER TRIM

Optional



CHROME
T14238



STAINLESS STEEL
T14238-SS



CHAMPAGNE BRONZE
T14238-CZ



VENETIAN BRONZE
T14238-RB



TRINSIC® SHOWER TRIM

Optional



CHROME
T14259-SS



STAINLESS STEEL
T14259-BL



CHAMPAGNE BRONZE
T14259-CZ



VENETIAN BRONZE
T14259-RB



HANDHELD SHOWER ILO STANDARD SHOWER HEAD

Optional 5-Setting Two-in-One



CHROME
58569-PK



**STAINLESS
STEEL**
58569-SS-PK



**VENETIAN
BRONZE**
58569-RB-PK



**CHAMPAGNE
BRONZE**
58569-CZ-PK



CLASSIC ROMAN TUB TRIM
Standard



CHROME
T2705

CLASSIC ROMAN TUB TRIM
Optional



STAINLESS STEEL
T2705-SS

WOODHURST® ROMAN TUB TRIM

Optional



STAINLESS STEEL
T2732-SS



VENETIAN BRONZE
T2732-RB



LAHARA® ROMAN TUB TRIM
Optional



CHROME
T2738



STAINLESS STEEL
T2738-SS



CHAMPAGNE BRONZE
T2738-CZ



VENETIAN BRONZE
T2738-RB



TRINSIC® ROMAN TUB TRIM

Optional



MATTE BLACK
T2759-BL



STAINLESS STEEL
T2759-SS



CHAMPAGNE BRONZE
T2759-CZ



VENETIAN BRONZE
T2759-RB



BATHROOM LIGHTS

Standard Above 24" – 36" Vanities

BULBS INCLUDED



LANSING BRUSHED PEWTER 3072BPW



LANSING RUBBED BRONZE 3072RBZ

BATHROOM LIGHTS

Optional

BULBS INCLUDED



**FRANKLIN BRUSHED PEWTER
3222BPW**



**FRANKLIN RUBBED BRONZE
3222RBZ**



**CIMMARON SATIN NICKEL
2162SN**



**CIMMARON RUBBED BRONZE
2162RBZ**



**NATALIE SATIN NICKEL
1492SN**



**NATALIE RUBBED BRONZE₂₁₃
1492RBZ**

BATHROOM LIGHTS

Standard Above 42" – 48" Vanities

BULBS INCLUDED



LANSING BRUSHED PEWTER 3073RBZ



LANSING RUBBED BRONZE 3073RBZ

BATHROOM LIGHTS

Optional

BULBS INCLUDED



**FRANKLIN BRUSHED PEWTER
3223BPW**



**FRANKLIN RUBBED BRONZE
3223RBZ**



**CIMMARON SATIN NICKEL
2163SN**



**CIMMARON RUBBED BRONZE
2163RBZ**



**NATALIE SATIN NICKEL
1493SN**



**NATALIE RUBBED BRONZE₂₁₅
1493RBZ**

BATHROOM LIGHTS

Optional

BULBS INCLUDED



BURBANK MATTE BLACK 172MB



BURBANK MATTE BLACK 173MB

BATHROOM VANITY MIRROR

Standard



Mirror & 2-Bulb Light Fixture Standard Above 24" – 36" Vanities
Mirror & 3-Bulb Light Fixture Standard Above 42" – 48" Vanities

FRAMED MIRROR

Optional

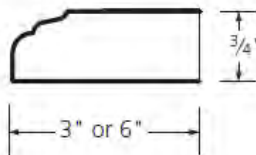
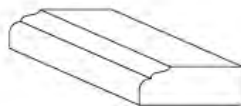

Mirror Molding Matches Cabinet Color

BATH FAN
Standard



FLEX SERIES 70 CFM BATHROOM EXHAUST FAN WITH LIGHT

2.0 SONES FOR QUIET PERFORMANCE

A70L

BATH FAN
Optional



BROAN® 70 CFM HEATER/VENTILATION FAN/LIGHT

4.0 AUDIBLE SONES FOR PRIVACY

655

BATH FAN
Optional



FLEX SERIES 80 CFM BATHROOM EXHAUST FAN WITH LIGHT

.08 SONES FOR ULTRA QUIET PERFORMANCE

AE80L



BATH FAN
Optional



BROAN® LoPROFILE™ 80 CFM VENTILATION FAN

1.0 SONES FOR ULTRA QUIET PERFORMANCE

LP80



TUB/SHOWER with Curved Chrome Shower Rod
Standard



5' TUB/SHOWER WITH 15" APRON
MOLDED SOAP LEDGES
RE7901L or RE7901R

TUB/SHOWER with Curved Chrome Shower Rod Standard

Standard AcrylX™ Colors

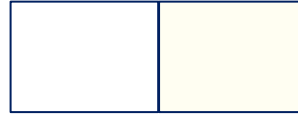

WHITE

BISCUIT

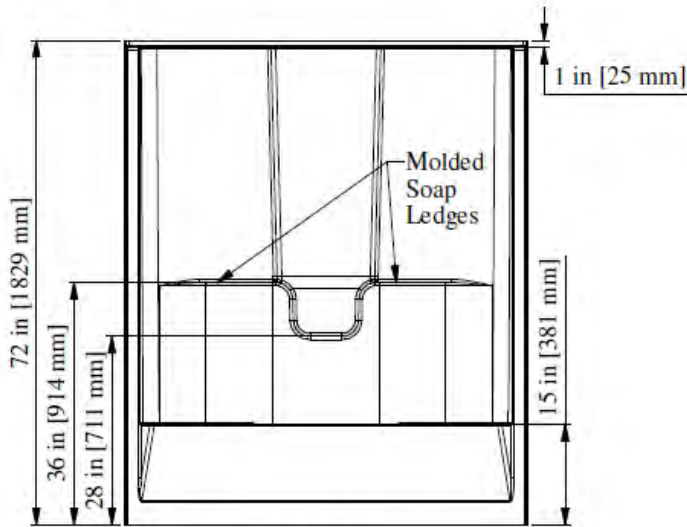

ELEVATION

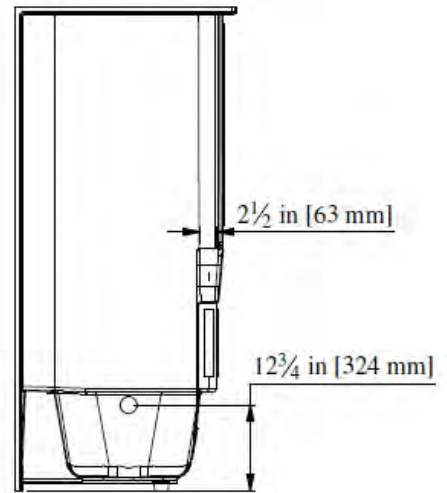

SECTION A-A

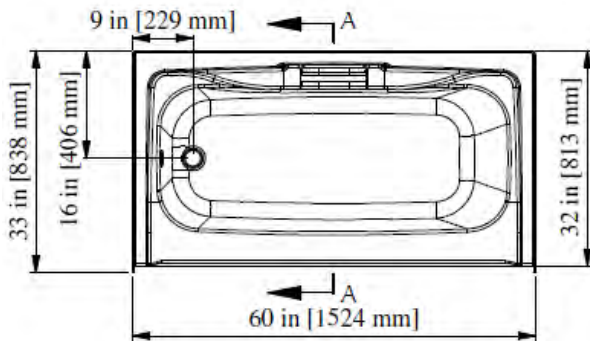

PLAN

60" [1524mm] Tub/Shower
w/ Molded Soap Ledges

PRODUCT SPECIFICATIONS:

- * Product complies with NAHB, HUD UM-73A, and ANSI-Z124.1.2.
- * Reinforced & slip resistant floor.
- * Molded soap ledges on back wall.
- * Integral 1" [25mm] nailing flange.
- * Available with factory installed 1" [25mm] acrylic towel bar, model number becomes (7901LT or 7901RT)
- * Factory drilled 2-1/2" overflow.
- * Bathwell Dimensions (At Top): W-51-3/4" [1315mm]
D-21" [533mm]
H-14-3/4" [375mm]
- * Bathwell Dimensions (At Bottom): W-44" [1118mm]
D-16-3/4" [426mm]
- * Door Opening: W-55" [1397mm]
H-55 3/4" [1416mm]
- * Bathwell Capacity (At Overflow): 34 gal. [129L]
- * Water Level (At Overflow): 10" [279mm]
- * All dimensions +/- 1/2" [12.8mm]
- * A version with above the floor rough-in (7901LX or 7901RX) is available.
- * Clarion Bathware reserves the right to change design and/or dimensions.
- * Dimensions are the same for all other versions of this model. 224

GARDEN TUB with Curved Chrome Shower Rod
Optional



5' TUB/SHOWER WITH BOWED FRONT
MOLDED SHELVING, CENTER DRAIN
RE7941X (Available with Whirlpool Option)

GARDEN TUB with Curved Chrome Shower Rod

Optional

Standard AcrylX™ Colors

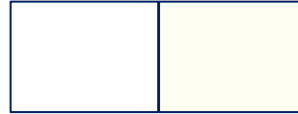

WHITE

BISCUIT

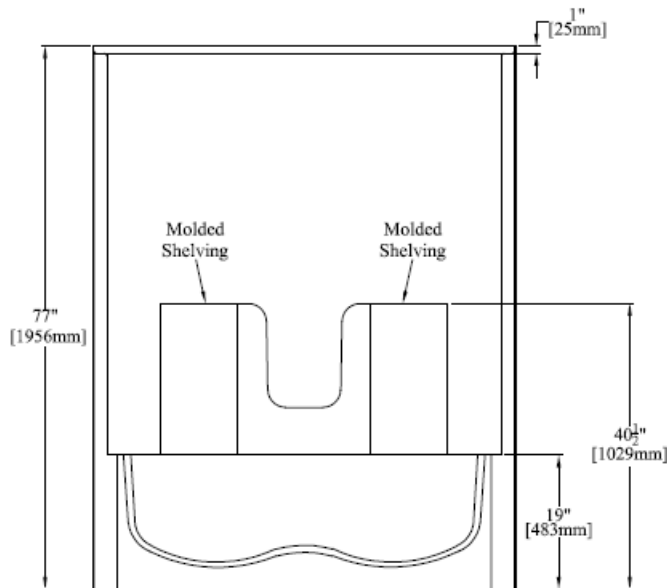

ELEVATION

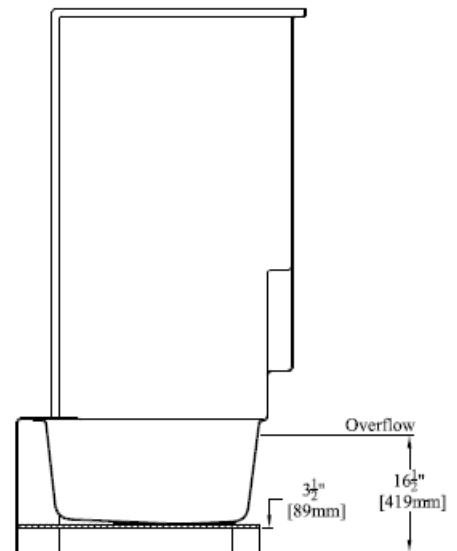

SECTION "A-A"

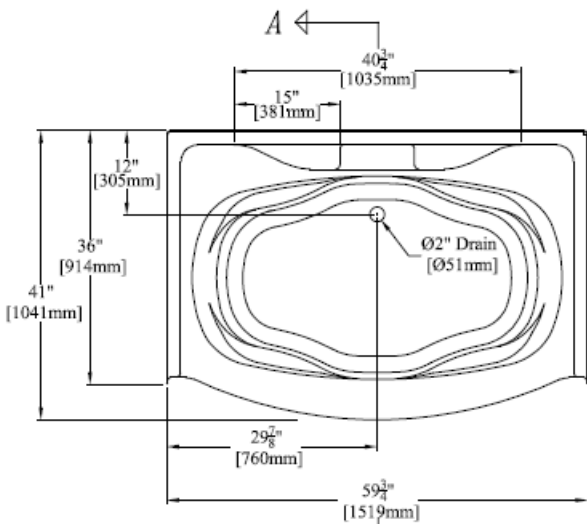

PLAN

*60" [1524mm] Tub/Shower
w/ Bowed Front, Center Drain & Molded Shelving*

PRODUCT SPECIFICATIONS:

- * Product complies with NAHB, HUD UM-73A, and ANSI-Z124.1.2.
- * Product has a Class B fire rating as determined by ASTM E-84 test method.
- * Reinforced & slip resistant floor.
- * Sufficient drain clearance to accommodate above the floor plumbing.
- * Integral 1" [25mm] nailing flange.
- * Spacious bathing well with molded arm rests.
- * Molded shelving.
- * Bathwell Dimensions (At Top): W-53 1/2" [1410mm]
D-30" [679mm]
H-13 1/2" [343mm]
- * Bathwell Dimensions (At Bottom): W-48" [1181mm]
D-26" [648mm]
- * Bathwell Capacity (At Overflow): 61 Gal [231L]
- * Water Level (At Overflow): 10" [254mm]
- * All dimensions +/- 1/2" [12.8mm]
- * Clarion Bathware reserves the right to change design and/or dimensions.
- * Dimensions are the same for RE, MP, and all other versions of this model.

GARDEN TUB with Curved Chrome Shower Rod with 8-Jet Whirlpool Option

Optional

Standard AcrylX™ Colors

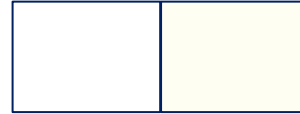

WHITE

BISCUIT

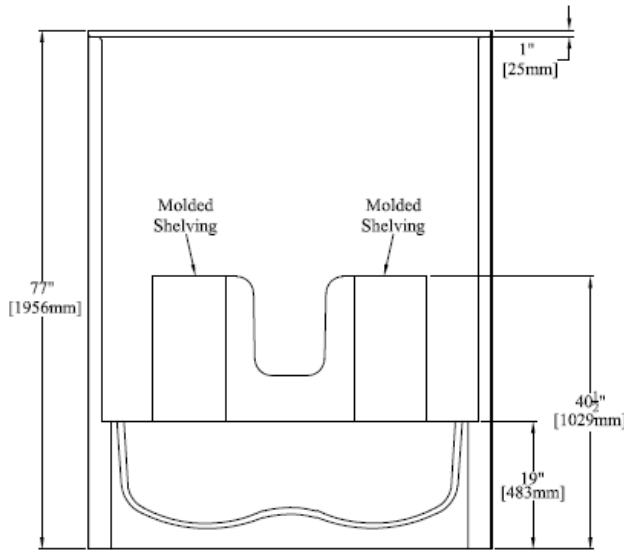

ELEVATION

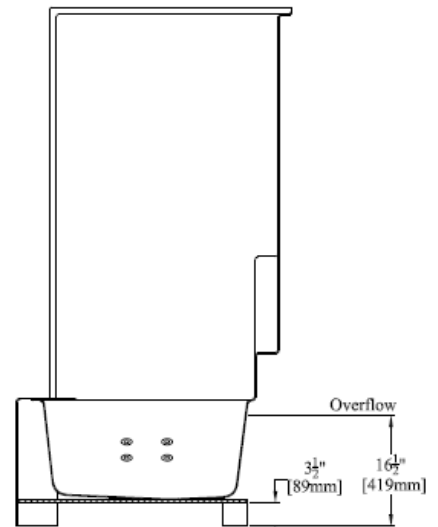

SECTION "A-A"

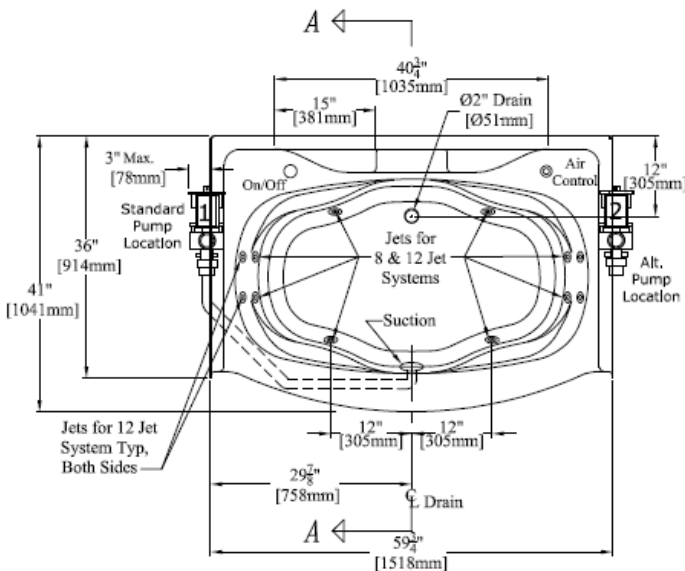

PLAN

60" [1524mm] Tub/Shower

w/ Bowed Front, Center Drain & Molded Shelving

PRODUCT SPECIFICATIONS:

- * Product complies with NAHB, HUD UM-73A, and ANSI-Z124.1.2.
- * Product has a Class B fire rating as determined by ASTM E-84 test method.
- * When installing this whirlpool, an access area should be provided near the location of the whirlpool pump for future access. An access area is required by many local, state & federal building codes.
- * Recommended access area dimensions: W-20" [508mm] H-15" [381mm]
- * Reinforced & slip resistant floor.
- * Sufficient drain clearance to accommodate above the floor plumbing.
- * Integral 1" [25mm] nailing flange.
- * Spacious bathing well with molded arm rests.
- * Molded shelving.
- * Bathwell Dimensions (At Top): W-53 1/2" [1410mm] D-30" [679mm] H-13 1/2" [343mm]
- * Bathwell Dimensions (At Bottom): W-48" [1181mm] D-26" [648mm]
- * Bathwell Capacity (At Overflow): 61 Gal [231L]
- * Water Level (At Overflow): 10" [254mm]
- * The pump will stick out 3" from the rough-in dimensions on 6 jet versions of this product.
- * All dimensions +/- 1/2" [12.8mm]
- * Clarion Bathware reserves the right to change design and/or dimensions.
- * Dimensions are the same for RE, MP, and all other versions of this model.

LOW-WALL BOWED-FRONT SOAKING TUB

Optional



**5' TUB WITH BOWED FRONT, LOW-WALL
CENTER DRAIN
RE4641X (Available with Whirlpool Option)**

LOW-WALL BOWED-FRONT SOAKING TUB

Optional

Standard AcrylX™ Colors

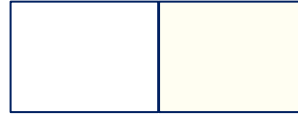

WHITE

BISCUIT

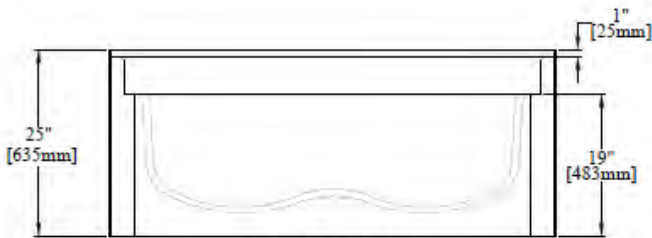

ELEVATION

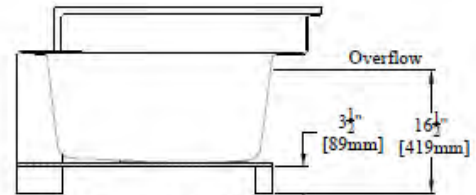

SECTION "A-A"

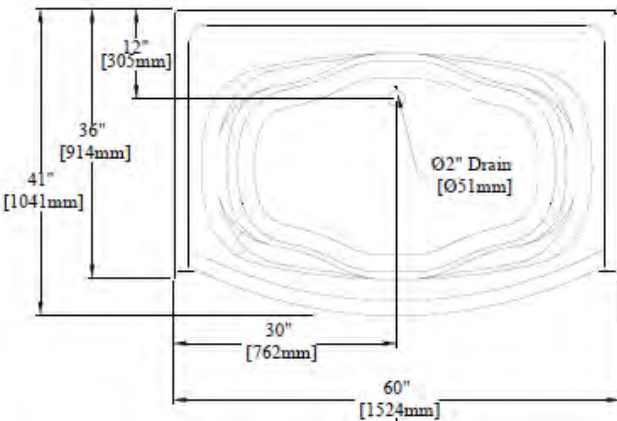
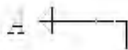

PLAN

60" [1524mm] Tub/Shower

w/ Bowed Front, Center Drain & Molded Arm Rests

PRODUCT SPECIFICATIONS:

- * Product complies with NAHB, HUD UM-73A, and ANSI-Z124.1.2.
- * Product has a Class B fire rating as determined by ASTM E-84 test method.
- * Reinforced & slip resistant floor.
- * Sufficient drain clearance to accommodate above the floor plumbing.
- * Integral 1" [25mm] nailing flange.
- * Spacious bathing well with molded arm rests.
- * Bathwell Dimensions (At Top): W-53 1/2" [1410mm]
D-30" [679mm]
H-13 1/2" [343mm]
- * Bathwell Dimensions (At Bottom): W-48" [1181mm]
D-26" [648mm]
- * Bathwell Capacity (At Overflow): 61 Gal [231L]
- * Water Level (At Overflow): 10" [254mm]
- * All dimensions +/- 1/2" [12.8mm]
- * Clarion Bathware reserves the right to change design and/or dimensions.
- * Dimensions are the same for RE, MP, and all other versions of this model.

LOW-WALL BOWED-FRONT SOAKING TUB with 8-Jet Whirlpool Option

Optional

Standard AcrylX™ Colors

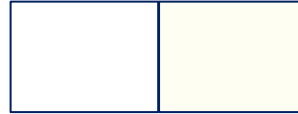

WHITE BISCUIT

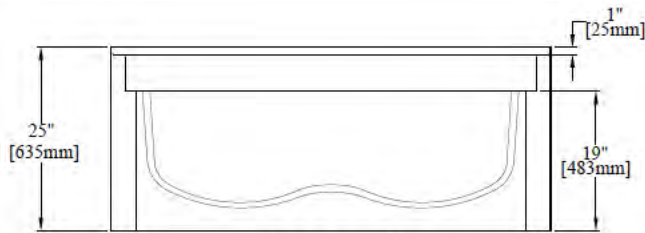

ELEVATION

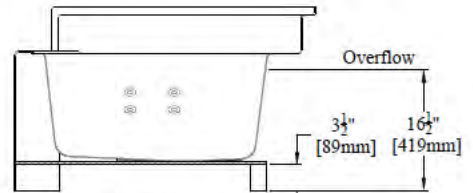

SECTION "A-A"

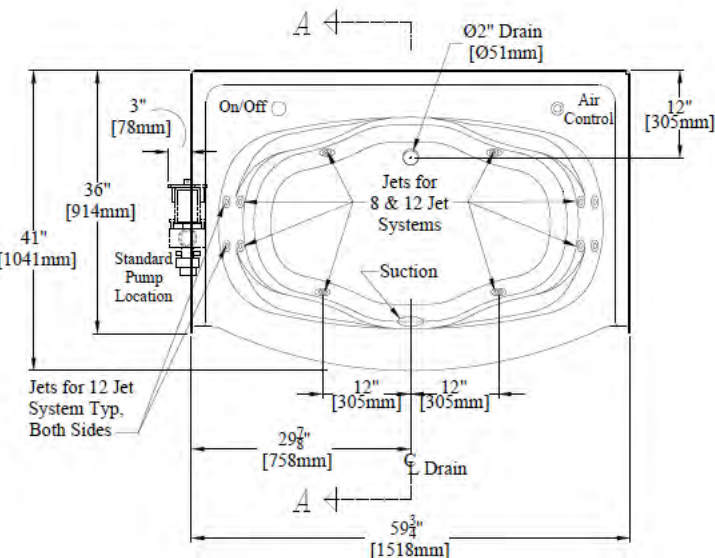

PLAN

60" [1524mm] Tub

w/ Bowed Front, Center Drain, Molded Arm Rests
& 8 or 12 Jet Whirlpool Package

PRODUCT SPECIFICATIONS:

- * Product complies with NAHB, HUD UM-73A, and ANSI-Z124.1.2.
- * Product has a Class B fire rating as determined by ASTM E-84 test method.
- * When installing this whirlpool, an access area should be provided near the location of the whirlpool pump for future access. An access area is required by many local, state & federal building codes.
- * Recommended access area dimensions: W-20" [508mm]
H-15" [381mm]
- * Reinforced & slip resistant floor.
- * Sufficient drain clearance to accommodate above the floor plumbing.
- * Integral 1" [25mm] nailing flange.
- * Spacious bathing well with molded arm rests.
- * Bathwell Dimensions (At Top): W-53 1/2" [1410mm]
D-30" [679mm]
H-13 1/2" [343mm]
- * Bathwell Dimensions (At Bottom): W-48" [1181mm]
D-26" [648mm]
- * Bathwell Capacity (At Overflow): 61 Gal [231L]
- * Water Level (At Overflow): 10" [254mm]
- * The pump will stick out 3" from the rough-in dimensions on 6 jet versions of this product.
- * All dimensions +/- 1/2" [12.8mm]
- * Clarion Bathware reserves the right to change design and/or dimensions.
- * Dimensions are the same for RE, MP, and all other versions of this model.

ROMAN TUB
Optional



5' ACRYLIC DROP-IN BATHTUB
MOLDED ARM RESTS
AD566062 (Available with Whirlpool Option)

ROMAN TUB

Optional

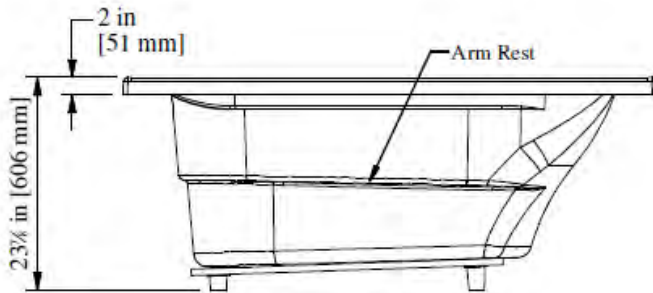

ELEVATION

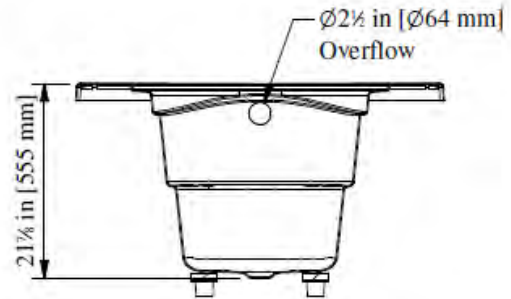

SECTION A-A

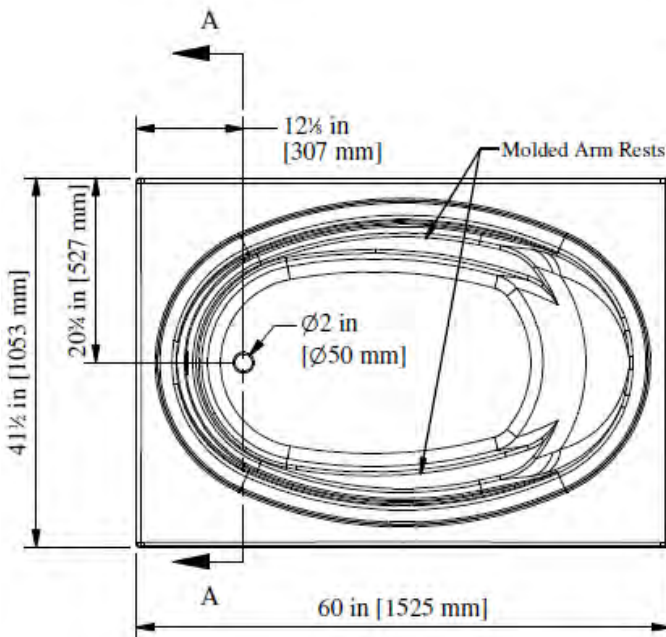

PLAN

**60" [1524mm] Acrylic Drop-In Bathtub
w/ Molded Arm Rests**

PRODUCT SPECIFICATIONS:

- Product complies with NAHB, HUD UM-73A, and ANSI-Z124.1.2.
- Clarion Bathware acrylic products are thermoformed from continuous cast acrylic sheet into a one piece seamless unit.
- A tiling flange kit is available (Model TFK-1).
- Reinforced & slip resistant floor.
- Integral 2" [51mm] rolled edge for drop-in installation.
- Factory drilled 2 1/2" [64mm] overflow.
- Molded arm rests
- Bathwell Dimensions (At Top): W-49 3/4" [1264mm]
D-42" [610mm]
H-21" [533mm]
- Bathwell Dimensions (At Bottom): W-37 1/2" [953mm]
D-24" [610mm]
- Bathwell Capacity (At Overflow): 57 Gallons [215L]
- Water Level (At Overflow): 18" [457mm]
- All dimensions +/- 1/2" [12.8mm]
- Clarion Bathware reserves the right to change design and/or dimensions.

ROMAN TUB with 8-Jet WHIRLPOOL OPTION

Optional

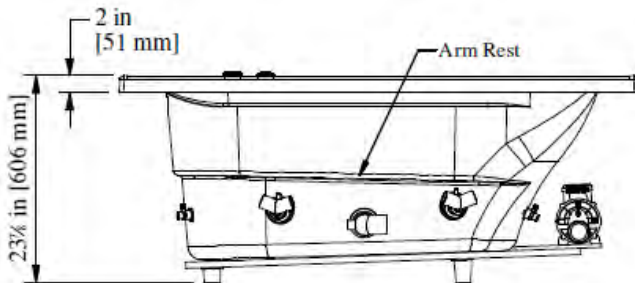

ELEVATION

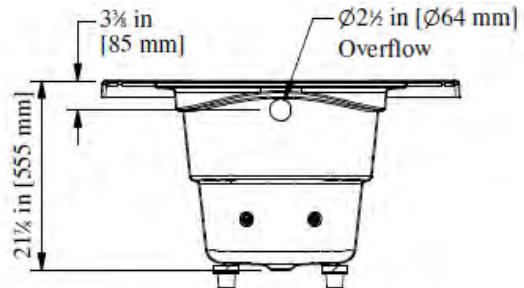

SECTION A-A

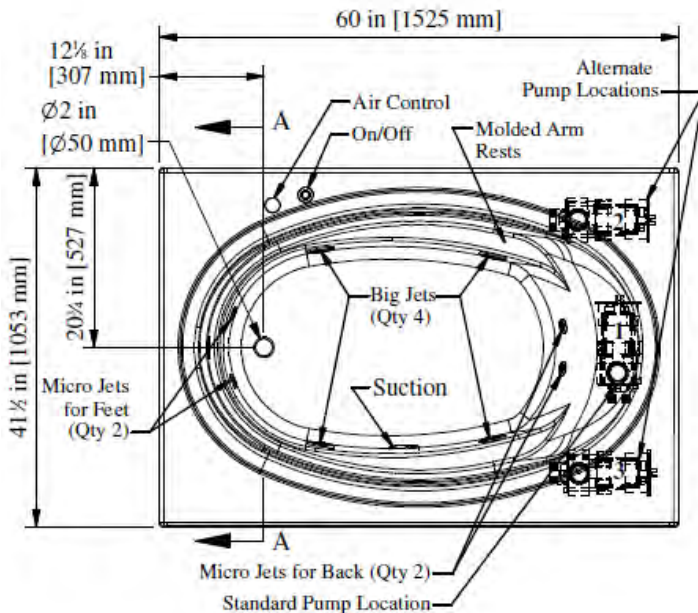

PLAN

**60" [1524mm] Acrylic Drop-In Bathtub
w/ Molded Arm Rests**

PRODUCT SPECIFICATIONS:

- Product complies with NAHB, HUD UM-73A, and ANSI-Z124.1.2.
- Clarion Bathware acrylic products are thermoformed from continuous cast acrylic sheet into a one piece seamless unit.
- When installing this whirlpool, an access area should be provided near the location of the whirlpool pump for future access. An access area is required by many local, state & federal building codes.
- Recommended access area dimensions:
W-20" [508mm] x H-15" [381mm]
- A tiling flange kit is available (Model TFK-1).
- Reinforced & slip resistant floor.
- Integral 2" [51mm] rolled edge for drop-in installation.
- Factory drilled 2 1/2" [64mm] overflow.
- Molded arm rests
- Bathwell Dimensions (At Top): W-49 3/4" [1264mm]
D-42" [610mm]
H-21" [533mm]
- Bathwell Dimensions (At Bottom): W-37 1/2" [953mm]
D-24" [610mm]
- Bathwell Capacity (At Overflow): 57 Gallons [215L]
- Water Level (At Overflow): 18" [457mm]
- All dimensions +/- 1/2" [12.8mm]
- Clarion Bathware reserves the right to change design and/or dimensions.

ROMAN TUB
Standard



6' DROP-IN BATHTUB
RE4272DS (Available with Whirlpool Option)

ROMAN TUB

Standard

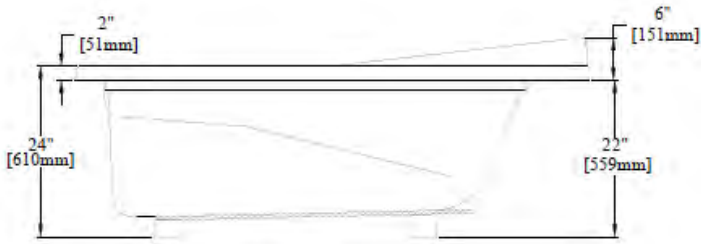

ELEVATION

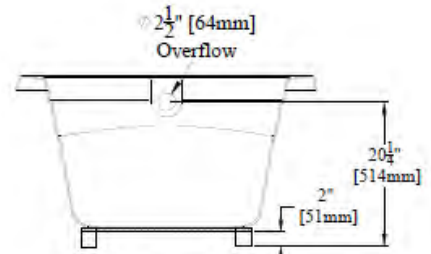

SECTION "A-A"

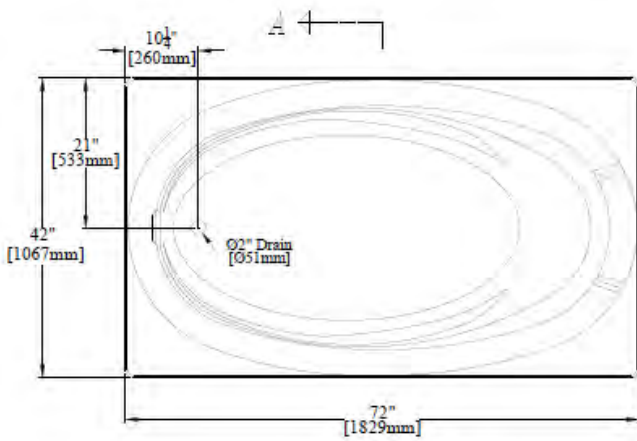

PLAN

72" [1829mm] Drop-in Bathub

Standard AcrylX™ Colors

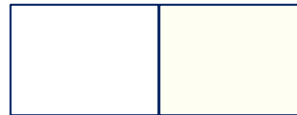

WHITE

BISCUIT

PRODUCT SPECIFICATIONS:

- * Product complies with NAHB, HUD UM-73A, and ANSI-Z124.1.2.
- * Product has a Class B fire rating as determined by ASTM E-84 test method.
- * Reinforced & slip resistant floor.
- * Integral rolled edge for drop-in installation.
- * Bathwell Dimensions (At Top): W-65" [1651mm]
D-34 1/2" [1111mm]
H-21" [533mm]
- * Bathwell Dimensions (At Bottom): W-48 1/2" [1232mm]
D-24 1/2" [622mm]
- * Bathwell Capacity (At Overflow): 104 Gal. [394L]
- * Water Level (At Overflow): 16" [406mm]
- * Factory drilled 2 1/2" [64mm] overflow.
- * Spacious bathwell with molded arm rests and lumbar support.
- * All dimensions +/- 1/2" [12.8mm]
- * Clarion Bathware reserves the right to change design and/or dimensions.

ROMAN TUB with 8-Jet WHIRLPOOL OPTION

Optional

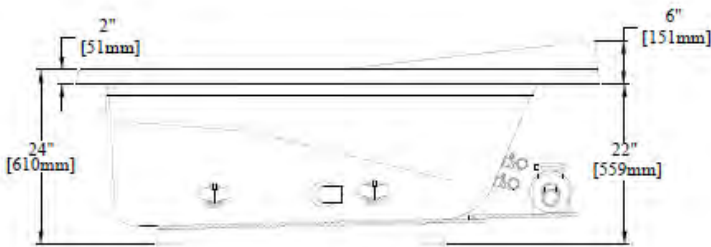

ELEVATION

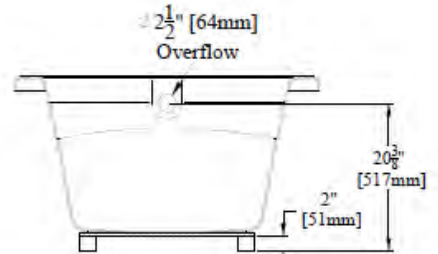

SECTION "A-A"

Standard AcrylX™ Colors

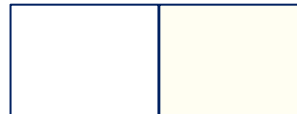

WHITE

BISCUIT

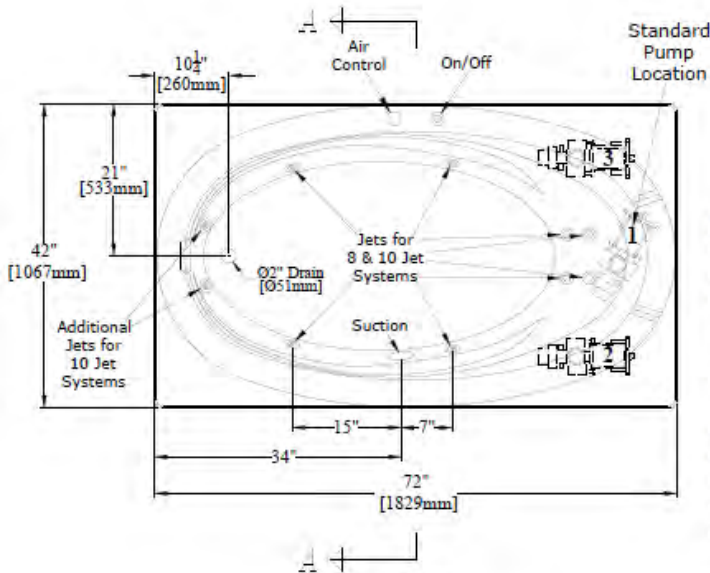

PLAN

72" [1829mm] Drop-in Bathtub
w/ 8 or 10 Jet Whirlpool Package

PRODUCT SPECIFICATIONS:

- * Product complies with NAHB, HUD UM-73A, and ANSI-Z124.1.2.
- * Product has a Class B fire rating as determined by ASTM E-84 test method.
- * When installing this whirlpool, an access area should be provided near the location of the whirlpool pump for future access. An access area is required by many local, state & federal building codes.
- * Recommended access area dimensions: W-20" [508mm]
H-15" [381mm]
- * Reinforced & slip resistant floor.
- * Integral rolled edge for drop-in installation.
- * Factory drilled 2 1/2" [64mm] overflow.
- * Spacious bathwell, with molded arm rests and lumbar support.
- * Bathwell Dimensions (At Top): W-65" [1651mm]
D-34 1/2" [1111mm]
H-21" [533mm]
- * Bathwell Dimensions (At Bottom): W-48 1/2" [1232mm]
D-24 1/2" [622mm]
- * Bathwell Capacity (At Overflow): 104 Gal. [394L]
- * Water Level (At Overflow): 16" [406mm]
- * This unit is available without an overflow (Model RE4272DSM:8 or RE4272DSM:A).
- * The pump positions labeled 2 & 3 are alternate pump locations that are available.
- * All dimensions +/- 1/2" [12.8mm]
- * Clarion Bathware reserves the right to change design and/or dimensions.

CORNER TUB
Optional



5' ACRYLIC DROP-IN BATHTUB
MOLDED ARM RESTS
AD956062 (Available with Whirlpool Option)

CORNER TUB

Optional

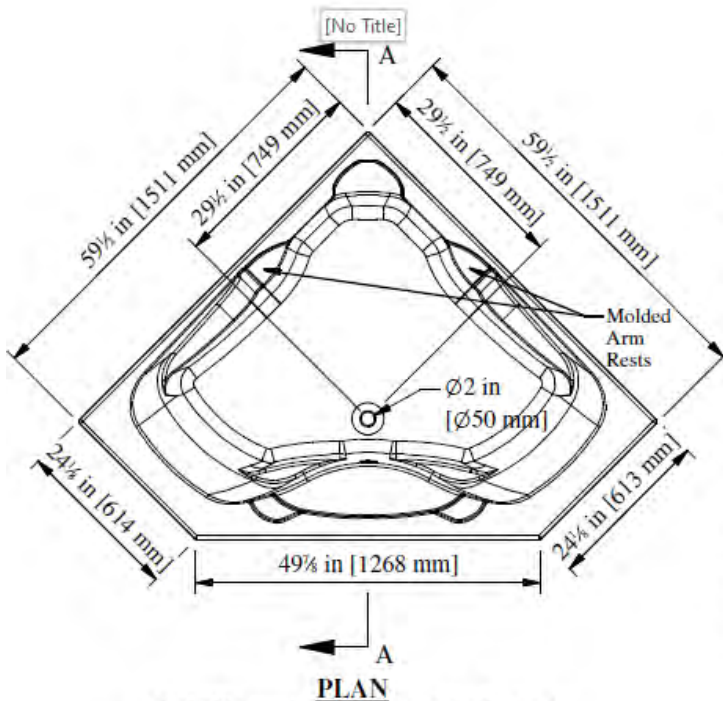
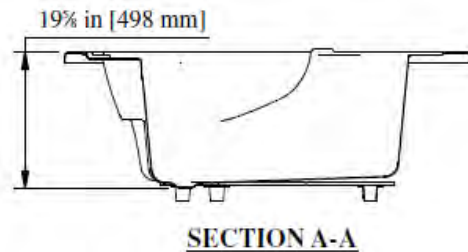
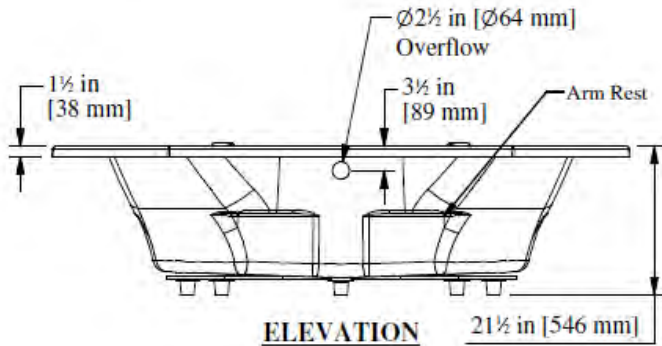

60" [1524mm] Acrylic Drop-In Bath tub
w/ Molded Arm Rests

PRODUCT SPECIFICATIONS:

- Product complies with NAHB, HUD UM-73A, and ANSI-Z124.1.2.
- Clarion Bathware acrylic products are thermoformed from continuous cast acrylic sheet into a one piece seamless unit.
- A tiling flange kit is available (Model TFK-1).
- Reinforced & slip resistant floor.
- Integral 1 1/2" [38mm] rolled edge for drop-in installation.
- Factory drilled 2 1/2" [64mm] overflow.
- Molded arm rests
- Bathwell Dimensions (At Top): W-68 1/2" [1740mm]
D-38 1/2" [978mm]
H-19" [483mm]
- Bathwell Dimensions (At Bottom): W-53" [1346mm]
D-35" [889mm]
- Bathwell Capacity (At Overflow): 85 Gallons [322L]
- Water Level (At Overflow): 14 3/4" [375mm]
- All dimensions +/- 1/2" [12.8mm]
- Clarion Bathware reserves the right to change design and/or dimensions.

CORNER TUB with 8-Jet WHIRLPOOL OPTION

Optional

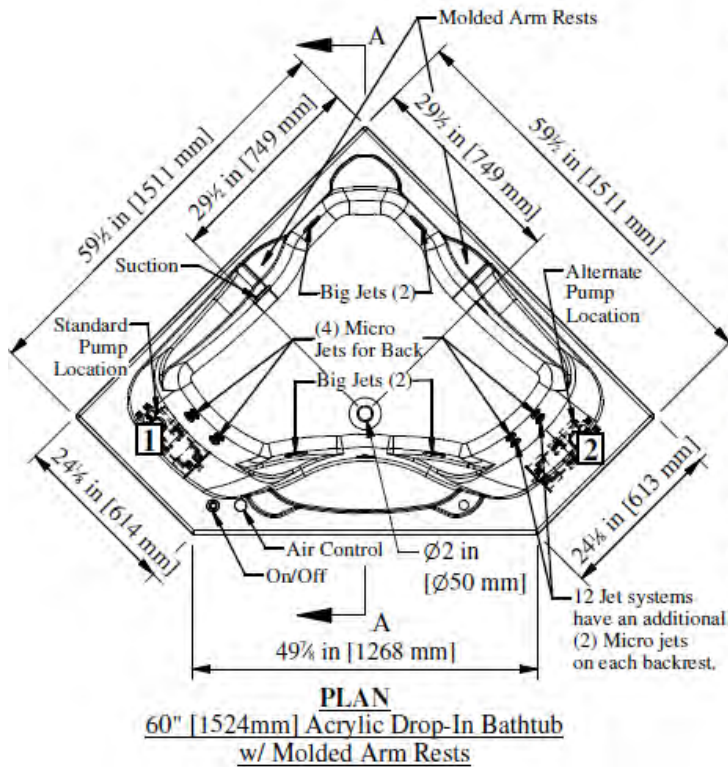
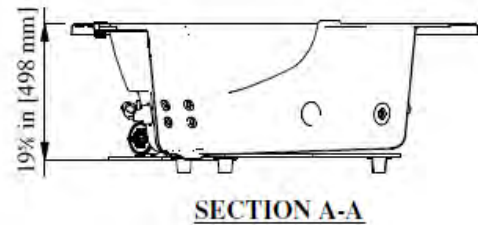
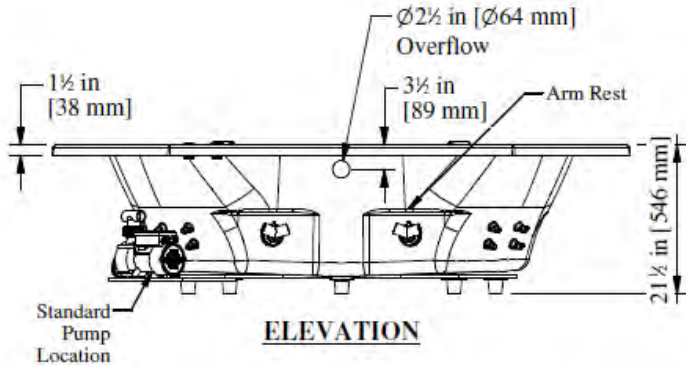

PRODUCT SPECIFICATIONS:

- Product complies with NAHB, HUD UM-73A, and ANSI-Z124.1.2.
- Clarion Bathware acrylic products are thermoformed from continuous cast acrylic sheet into a one piece seamless unit
- When installing this whirlpool, an access area should be provided near the location of the whirlpool pump for future access. An access area is required by many local, state & federal building codes.
- Recommended access area dimensions:
 W-20" [508mm] x H-15" [381mm]
- A tiling flange kit is available (Model TFK-1).
- Reinforced & slip resistant floor.
- Integral 1 1/2" [38mm] rolled edge for drop-in installation.
- Factory drilled 2 1/2" [64mm] overflow.
- Molded arm rests
- Bathwell Dimensions (At Top): W-68 1/2" [1740mm]
 D-38 1/2" [978mm]
 H-19" [483mm]
- Bathwell Dimensions (At Bottom): W-53" [1346mm]
 D-35" [889mm]
- Bathwell Capacity (At Overflow): 85 Gallons [322L]
- Water Level (At Overflow): 14 3/4" [375mm]
- All dimensions +/- 1/2" [12.8mm]
- Clarion Bathware reserves the right to change design and/or dimensions.

SHOWER with Chrome 3500 Shower Door
Optional



5' SHOWER WITH 4" THRESHOLD
MOLDED SEAT, CORNER SOAP LEDGES, CENTER DRAIN
RE6036LSD/S or RE6036RSD/S
with 3500-60-70-OB-SV

SHOWER with Chrome 3500 Shower Door

Optional

Standard AcrylX™ Colors

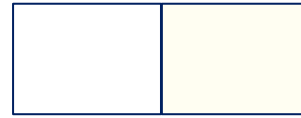

WHITE

BISCUIT

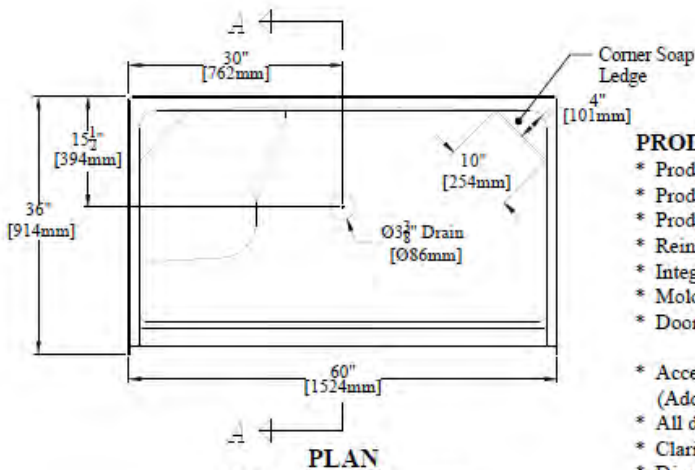
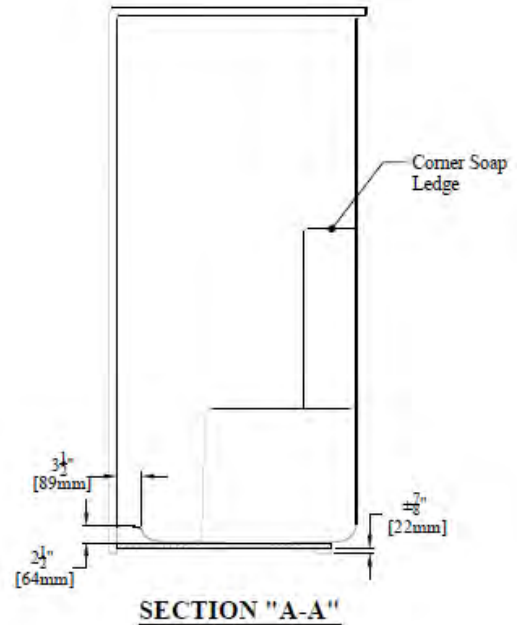
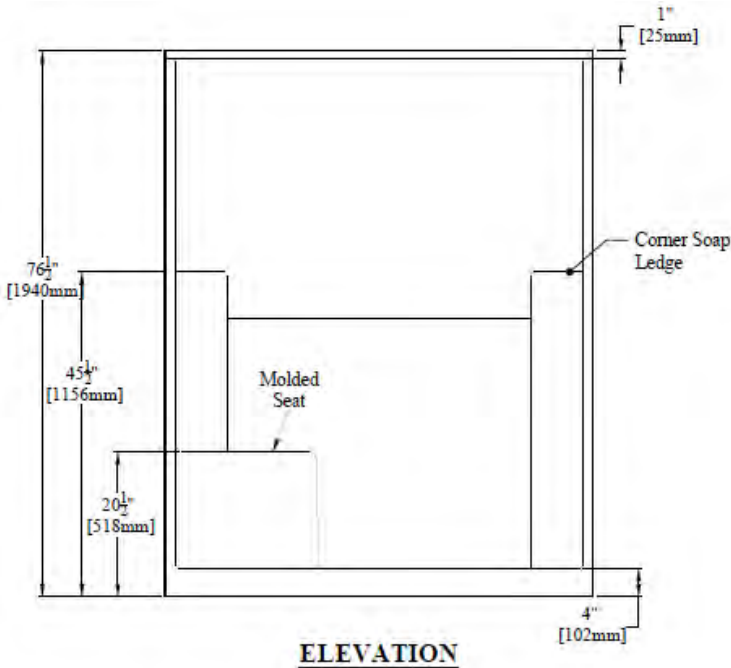

60" [1524mm] Shower

w/ 4" [102mm] Threshold, Molded Seat & Corner Soap Ledges

PRODUCT SPECIFICATIONS:

- * Product complies with NAHB, HUD UM-73A, and ANSI-Z124.1.2.
- * Product complies with FHA & UFAS 4.34.5.5 when structured properly.
- * Product has a Class B fire rating as determined by ASTM E-84 test method.
- * Reinforced & slip resistant floor.
- * Integral 1" [25mm] nailing flange.
- * Molded seat approx. 18"W x 22 1/2"D x 18"H (opposite of valve wall).
- * Door Opening: W-56 3/4" [1441mm]
H-71" [1803mm]
- * Accepts Clarion Bathware Model #IN60C Dome (Adds 6" [152mm] to the overall height of the shower.)
- * All dimensions +/- 1/2" [12.8mm]
- * Clarion Bathware reserves the right to change design and/or dimensions.
- * Dimensions are the same for RE, MP, and all other versions of this model.

*Right Hand Version (6036RSD/S) Shown
CENTER DRAIN*

SHOWER with Chrome 3500 Shower Door
Optional



4' SHOWER WITH 6" THRESHOLD
MOLDED SEAT & SOAP LEDGES, CENTER DRAIN
RE5843L/S or RE5843R/S
with 3500-48-68-OB-SV

SHOWER with Chrome 3500 Shower Door

Optional

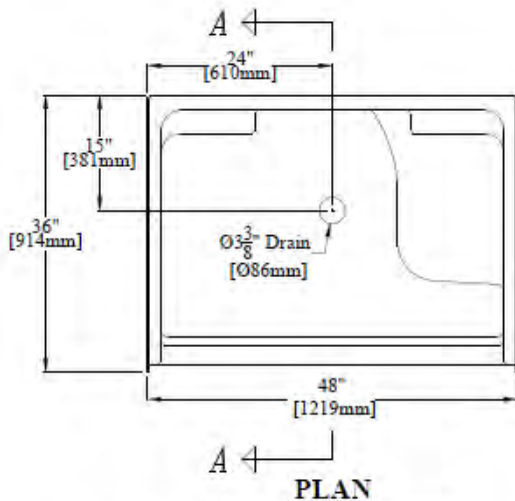
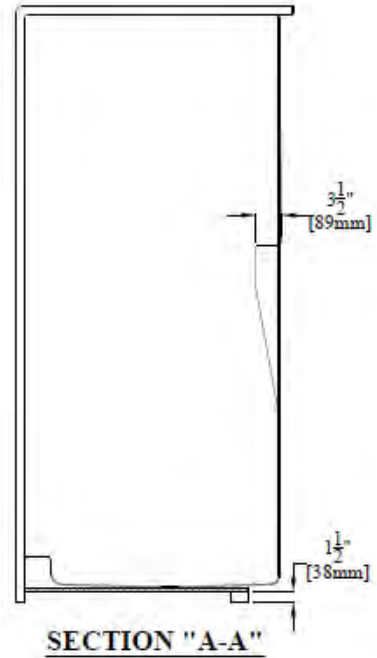
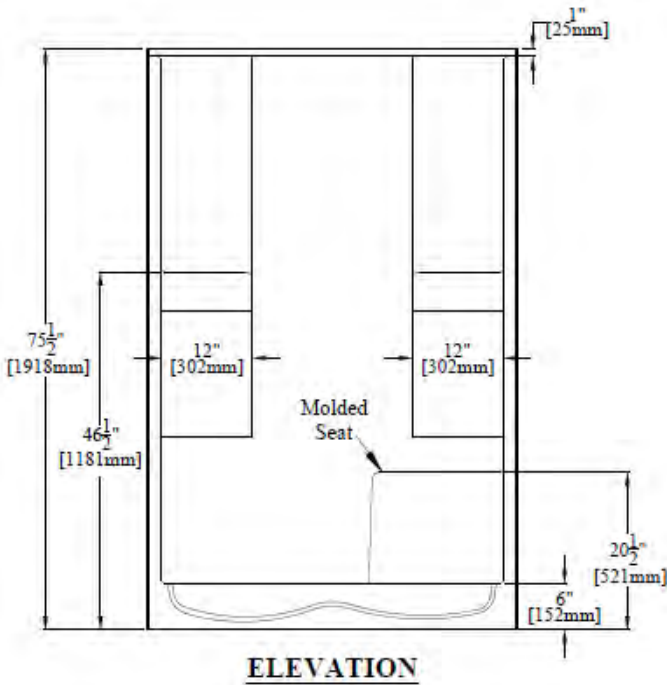

*48" [1219mm] Shower
w/ 6" [154mm] Threshold, Molded Seat*

*CENTER DRAIN
Left Hand Version (5843L/S) Shown*

Standard AcrylX™ Colors



WHITE BISCUIT

PRODUCT SPECIFICATIONS:

- * Product complies with NAHB, HUD UM-73A, and ANSI-Z124.1.2.
- * Product has a Class B fire rating as determined by ASTM E-84 test method.
- * Reinforced & slip resistant floor.
- * Integral 1" [25mm] nailing flange.
- * Molded soap ledges.
- * Molded seat approx. 14"W x 22 1/2"D x 18"H (opposite of valve wall).
- * Door Opening: W-44" [1118mm]
H-68" [1727mm]
- * Accepts Clarion Bathware Model RE948 cap (adds 8 1/2" [216mm] to the overall height of the unit)
- * All dimensions +/- 1/2" [12.8mm]
- * Clarion Bathware reserves the right to change design and/or dimensions.
- * Dimensions are the same for RE, MP, and all other versions of this model.

SEMI-FRAMELESS SHOWER DOORS

Standard

CLASSIC SEMI-FRAMELESS

The Classic semi-frameless glass shower doors enhance the look of any bathroom with bypass shower panels free from aluminum framing. One panel includes a pull handle for one edge of the glass and the other panel has a towel bar that wraps around the glass. *Chrome with obscure glass is the standard.*



3500

Frame Color Selections

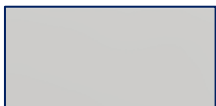

CHROME
Standard



BRUSHED NICKEL
Optional



OIL-RUBBED BRONZE
Optional



BRUSHED GOLD
Optional



WROUGHT IRON (BLACK)
Optional

SEMI-FRAMELESS SHOWER DOORS

Standard

Obscure Glass

Standard



Clear Glass

Optional



Rain Glass

Optional



SEMI-FRAMELESS SHOWER DOORS

Optional



3500
OIL-RUBBED BRONZE
RAIN GLASS

SHOWER with Chrome Hinged Shower Door
Optional



3' SHOWER WITH 6" THRESHOLD
MOLDED SOAP LEDGES & FOOT REST,
CENTER DRAIN
RE3636SD

SHOWER with Chrome Hinged Shower Door

Optional

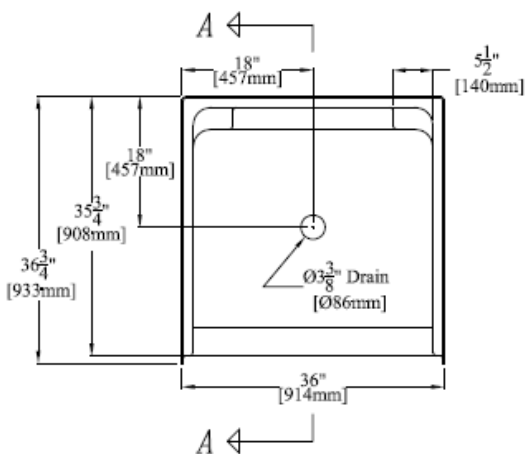
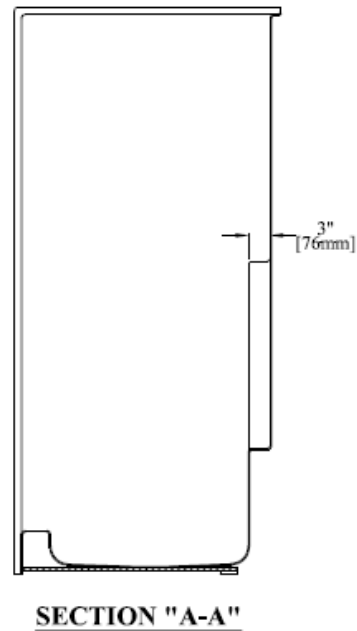
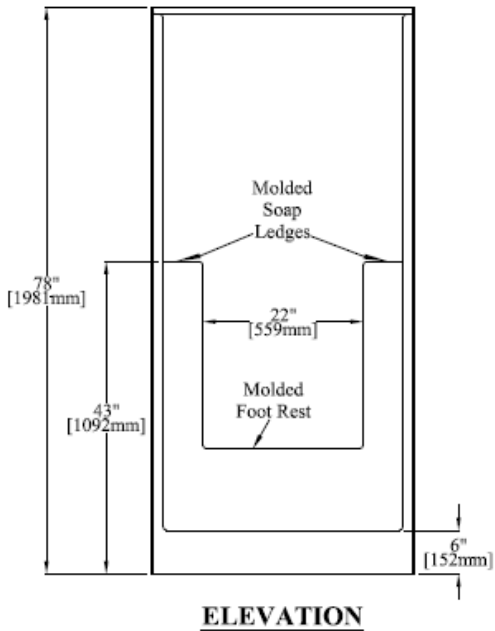

PLAN
*36" [914mm] Shower
w/ Molded Soap Ledges & Molded Foot Rest*
CENTER DRAIN

Standard AcrylX™ Colors

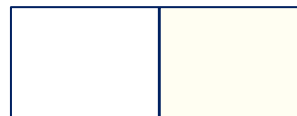

WHITE BISCUIT

PRODUCT SPECIFICATIONS:

- * Product complies with NAHB, HUD UM-73A, and ANSI-Z124.1.2.
- * Product has a Class B fire rating as determined by ASTM E-84 test method.
- * Does not meet minimum floor space requirements for most codes
- * Does not meet 36" diameter circle requirements for most codes
- * Reinforced & slip resistant floor.
- * Integral 1" [25mm] nailing flange.
- * Molded foot rest and soap ledges.
- * Door Opening: W-32 3/4" [832mm]
H-70 3/4" [1797mm]
- * Shower Floor: W-32 3/4" [832mm]
D-27 1/4" [692mm]
- * All dimensions +/- 1/2" [12.8mm]
- * Clarion Bathware reserves the right to change design and/or dimensions.
- * Dimensions are the same for RE, MP, and all other versions of this model.

SEMI-FRAMELESS SHOWER DOORS

Optional

CLASSIC SEMI-FRAMELESS

The Classic single panel shower enclosures use innovative engineering to create a suspended glass look to complement sophisticated bath decors. The clear drip vinyl keeps the water in the shower and the 3 inch magnetic handle that wraps the door makes sure the door latches to the unit.

3600A



Frame Color Selections

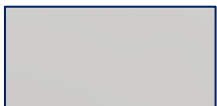

CHROME
Standard



BRUSHED NICKEL
Optional



OIL-RUBBED BRONZE
Optional



BRUSHED GOLD
Optional



WROUGHT IRON (BLACK)
Optional

SEMI-FRAMELESS SHOWER DOORS

Optional

Obscure Glass
Standard



Clear Glass
Optional



Rain Glass
Optional



WALK-IN SHOWER

Optional

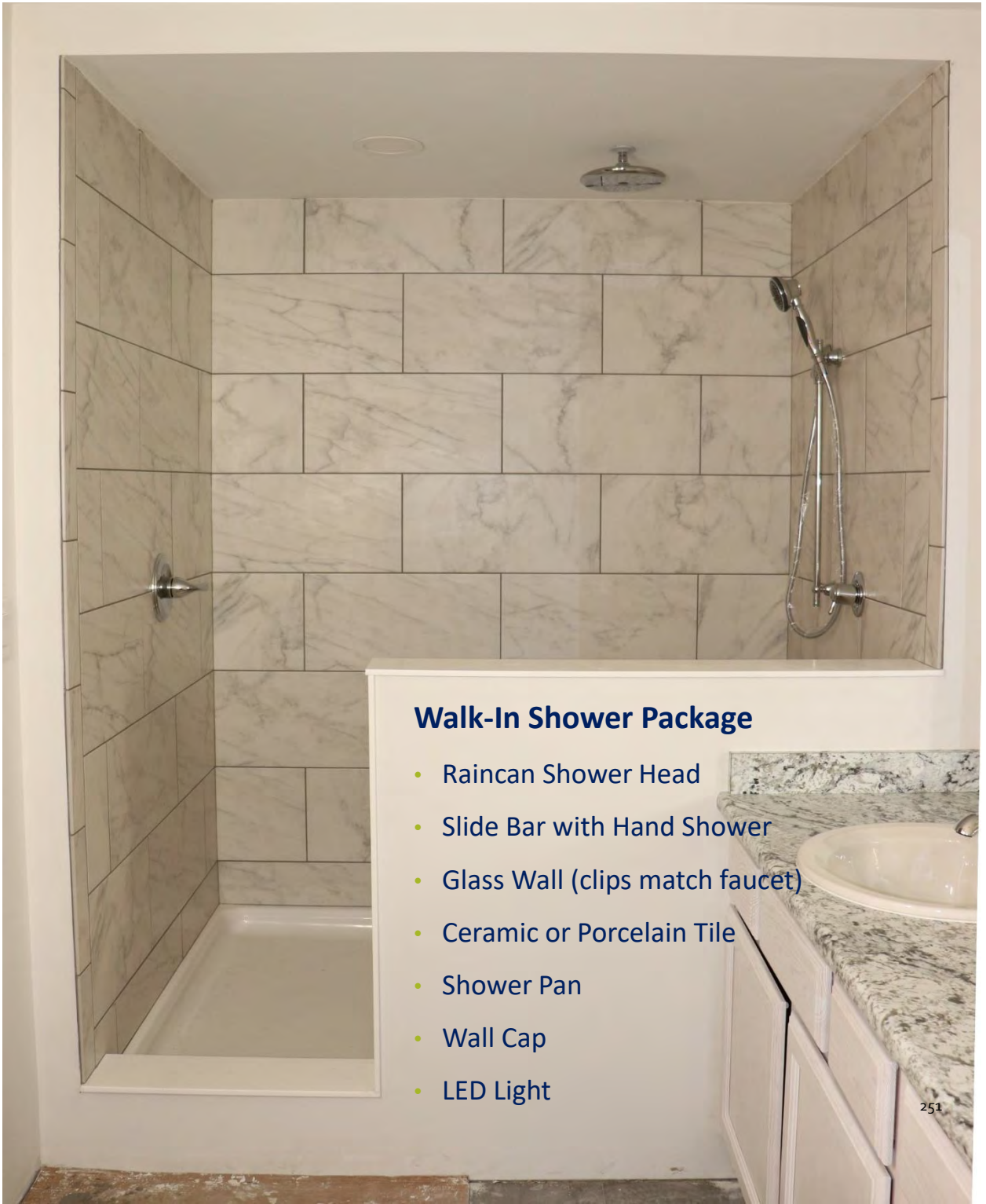

Walk-In Shower Package

- Raincan Shower Head
- Slide Bar with Hand Shower
- Glass Wall (clips match faucet)
- Ceramic or Porcelain Tile
- Shower Pan
- Wall Cap
- LED Light

WALK-IN-SHOWER / SHOWER PAN FOR TILE
Standard Option

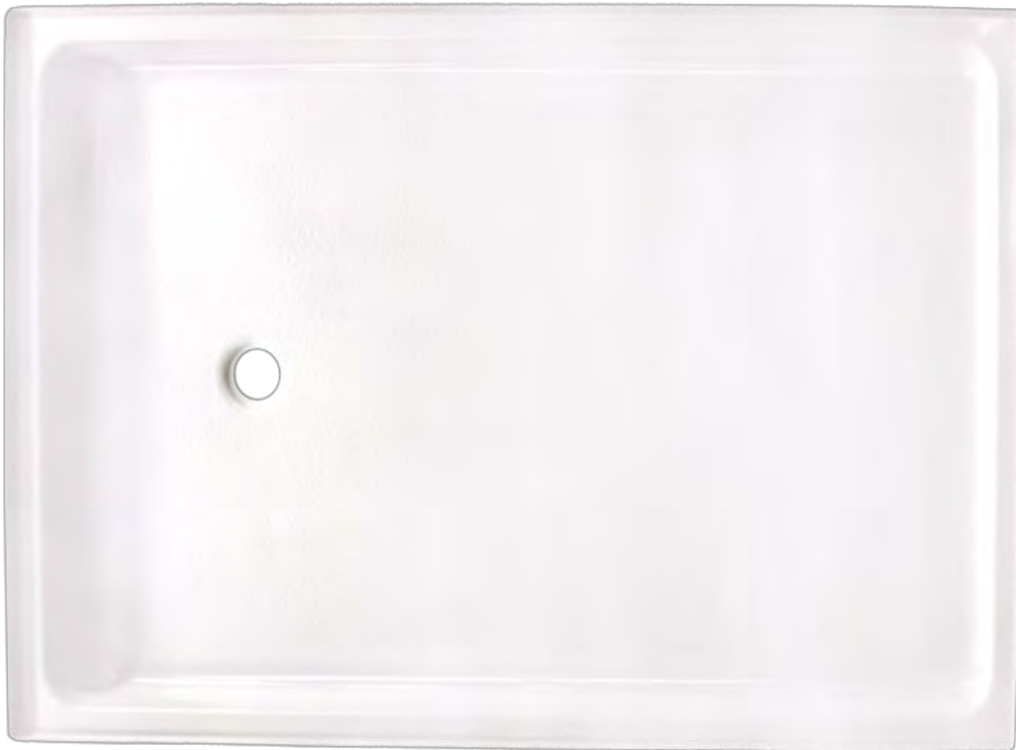

**6' SHOWER PAN with TILING FLANGE ALL SIDES,
NO THRESHOLD**
SP7248NT

WALK-IN-SHOWER / SHOWER PAN FOR TILE

Standard Option

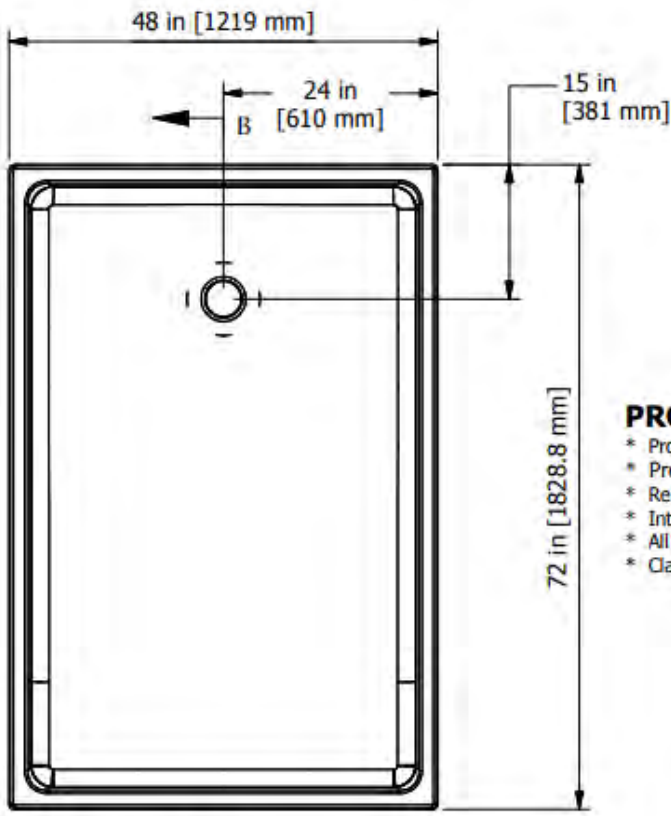
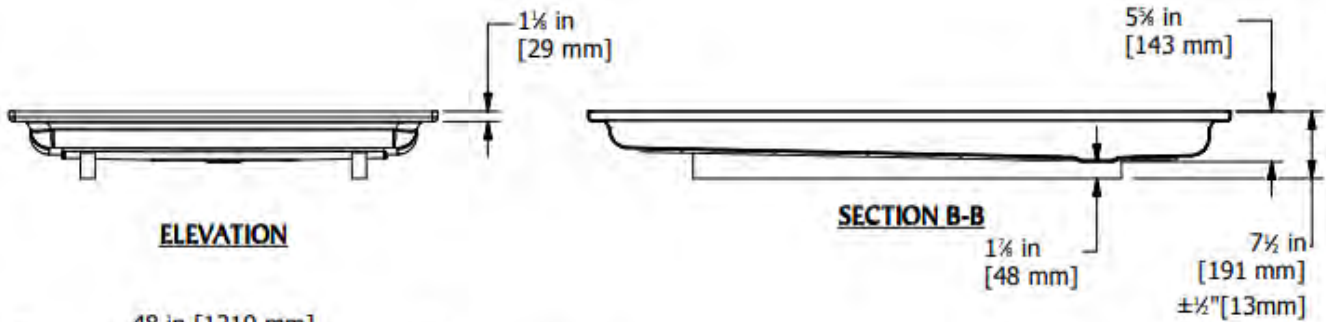

Standard AcrylX™ Colors

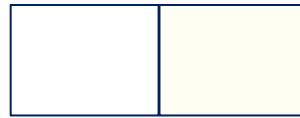

WHITE BISCUIT

PRODUCT SPECIFICATION:

- * Product complies with NAHB, HUD UM-73A, and NASI-Z124.1.2.
- * Product has a Class B fire rating as determined by ASTM E-84 test method.
- * Reinforced & slip resistant floor.
- * Integral 1" [25mm] nailing flange.
- * All dimensions +/- 1/4" [6.4mm] unless noted otherwise.
- * Clarion Bathware reserves the right to change design and/or dimensions.

← B

PLAN

72" [1829mm] x 48" [1219mm] Shower Pan
4 Tiling Flanges / No Threshold

END DRAIN

WALK-IN SHOWER / SLIDE-BAR HAND SHOWER

Standard Option



WALK-IN SHOWER / SLIDE-BAR HAND SHOWER

Optional Stainless Steel



WALK-IN SHOWER / SLIDE-BAR HAND SHOWER

Optional Bronze



WALK-IN SHOWER / SLIDE-BAR HAND SHOWER

Optional Champagne Bronze



WALK-IN SHOWER / SLIDE-BAR HAND SHOWER

Optional Matte Black



WALK-IN SHOWER / MAXIMUS SHOWER TILE 12 X 24
Standard Option

Standard Edging is Aluminum L-Shaped Trim



150 CARRARA
Grout Color White H152



170 CALACATTA
Grout Color White H152

WALK-IN SHOWER / CLASSICO SHOWER TILE 12 X 24

Standard Option

Standard Edging is Aluminum L-Shaped Trim



150 LIGHT GRAY
Grout Color Lunar H196



100 IVORY
Grout Color Mushroom H224



200 BEIGE
Grout Color Mushroom H224

WALK-IN SHOWER / VALENTINO SHOWER TILE 8 X 32

Standard Option

Standard Edging is Aluminum L-Shaped Trim

100 ACTION

Grout Color Lunar H196

500 CAMERA

Grout Color Delorean Grey H160

700 LIGHTS

Grout Color Latte H192

750 LEGEND

Grout Color Taupe H151

CORNER SHELF for Tiled Showers

Optional



TILE EDGE TRIM

Standard Option



ALUMINUM
Standard



SATIN NICKEL
Optional



BRONZE
Optional



BLACK
Optional

ALTO 1.28 ELONGATED TOILET

Standard



ALTO 135



BISCUIT
Optional



ALTO 1.28 ELONGATED SMARTHEIGHT TOILET

Optional



ALTO 137



BISCUIT
Optional



PEDESTAL SINK
Optional



ALTO IV 290

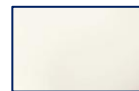

BISCUIT
Optional

CHROME BATH ACCESSORIES

Standard



**CONTEMPORARY
PAPER HOLDER**



**CONTEMPORARY
TOWEL HOLDER 18"**

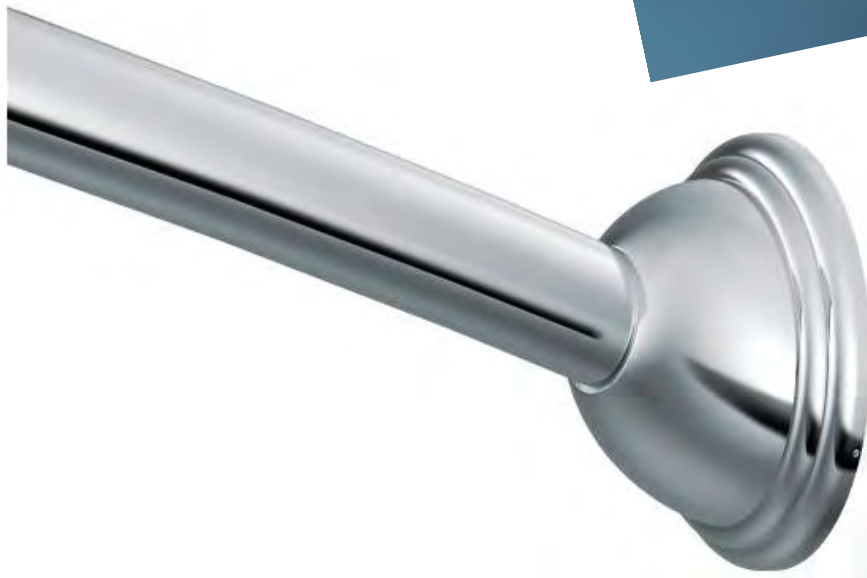

CURVED SHOWER ROD 5'

SHOWER CURTAIN ROD 5' CURVED

Optional



BRUSHED NICKEL
CSR2165BN



OLD WORLD BRONZE
CSR2165EOWB



BRUSHED GOLD
CSR2160BG



BLACK
CSR2160BL

CLASSIC® BATH COLLECTION*
Optional Faucet & Accessories



* Woodhurst® Paper Holder & 18" Towel Bar

WOODHURST® BATH COLLECTION
Optional Faucet & Accessories



WOODHURST® BATH ACCESSORIES

Optional



**WOODHURST SATIN NICKEL
73218-SS**



**WOODHURST VENETIAN BRONZE
73218-RB**



**WOODHURST SATIN NICKEL
73250-SS**



**WOODHURST VENETIAN BRONZE
73250-RB**

LAHARA® BATH COLLECTION
Optional Faucet & Accessories



LAHARA® BATH ACCESSORIES

Optional

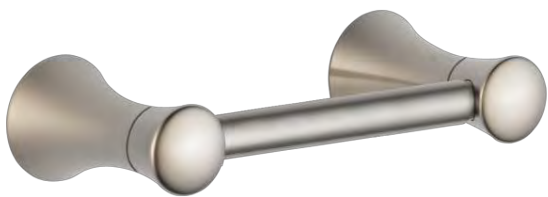
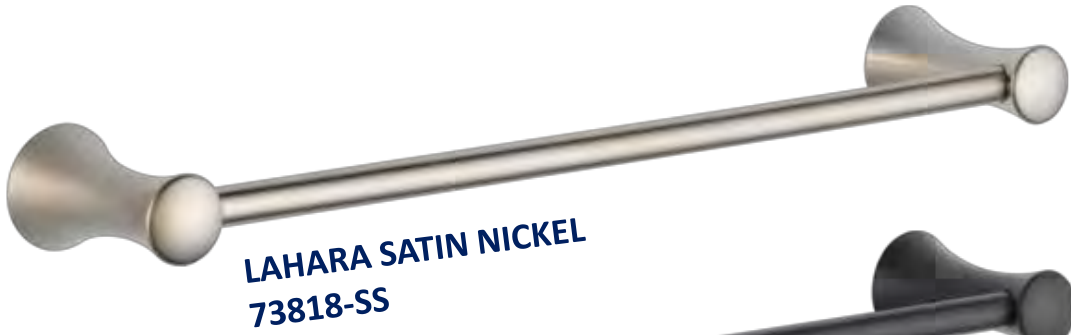

LAHARA SATIN NICKEL
73850-SS



LAHARA VENETIAN BRONZE
73850-RB



LAHARA CHAMPAGNE BRONZE
73850-CZ

TRINSIC® BATH COLLECTION

Optional Faucet & Accessories



TRINSIC® BATH ACCESSORIES

Optional



GRAB BARS

Optional



**Available in
24", 36", 42"**

- 18 gauge stainless steel
- Meets 900 lb. downward pull when installed properly
- Meets federal specification WW-P-541/8B, Amendment 1, 16 April 1990
- Meets ANSI 117.1 and all ADA Code requirements
- Meets federal specifications for FHA, VA hospital, private construction



50 GALLON ELECTRIC WATER HEATER

Optional

Professional Classic® electric water heaters are engineered for longer life.

Resistored copper upper element & resistored **Lifeguard™** stainless steel lower element to prolong anode rod and tank life.

Rheemglas® tank lining resists corrosion & prolongs tank life.

EverKleen® self cleaning device fights harmful sediment build-up with a high-velocity spiraling water stream – helps operating efficiency by saving energy, money and improving tank life.



PROE50 T2 RH95



UTILITY TUB SINK
Optional



MUSTEE 18
with Delta 2133LF Faucet

UTILITY CABINET with DROP-IN SINK

Optional

30" Minimum Base Cabinet



**MUSTEE 10
with Delta 2133LF Faucet**

VINYL LAP SIDING .42

Standard

Oak Harbor® Vinyl Siding

makes it easy to create an exterior with a fresh, laid-back style, while increasing a home’s value with its durability and beauty. With a palette of numerous colors, deep cedar embossed woodgrain texture, and contemporary low-luster finish, it conforms naturally to the design of any home. Maintenance is minimal, and repainting is unnecessary.



Color Selections



WHITE BIRCH 02



GRAPHITE GREY 49



SOFT WILLOW 41

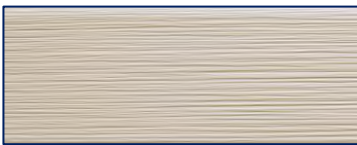

WARM SANDALWOOD 17

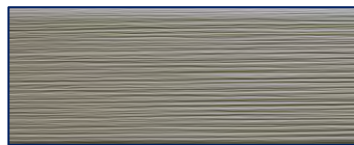

MEADOW 82



TWILIGHT 80



SUNNY MAIZE 22



ARTISAN CLAY 61

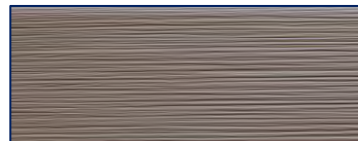

JAVA 52

WINDOW LINEALS

Optional

HOMEX Siding Accessories

Homex accessories are an industry standard in vinyl siding. Attractive & reliable components for installing vinyl siding. Engineered vinyl provides ruggedness with good color retention.

- Secure, positive locking systems
- Resists dents, hail damage, scratches & fading
- Never needs painting
- Impervious to wood-boring insects, fungus & mildew
- Matte Finish
- Limited Lifetime Warranty

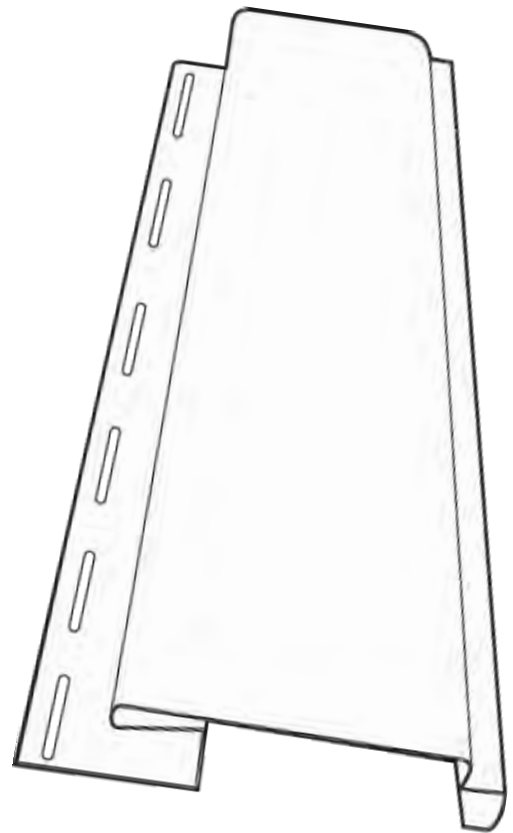

Color Selections

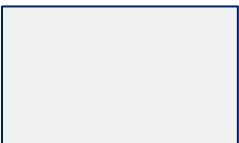

WHITE BIRCH

VINYL LAP SIDING .44

Optional

FairField® Vinyl Siding

With the most diverse selection of rich colors and deep-etched woodgrain patterns, FairField® vinyl siding offers you the highest-end styles to express yourself and give your dream home a beautiful new exterior. All FairField® products are made with Style Crest®'s proprietary tri-extrusion technology, which produces some of the highest quality vinyl siding available in the world. It combines the vibrant color of virgin cap stock with the durability of a premium-grade recycled PVC-blend core. The result is an exceptionally low-maintenance, long-lasting and durable choice in exterior home cladding.

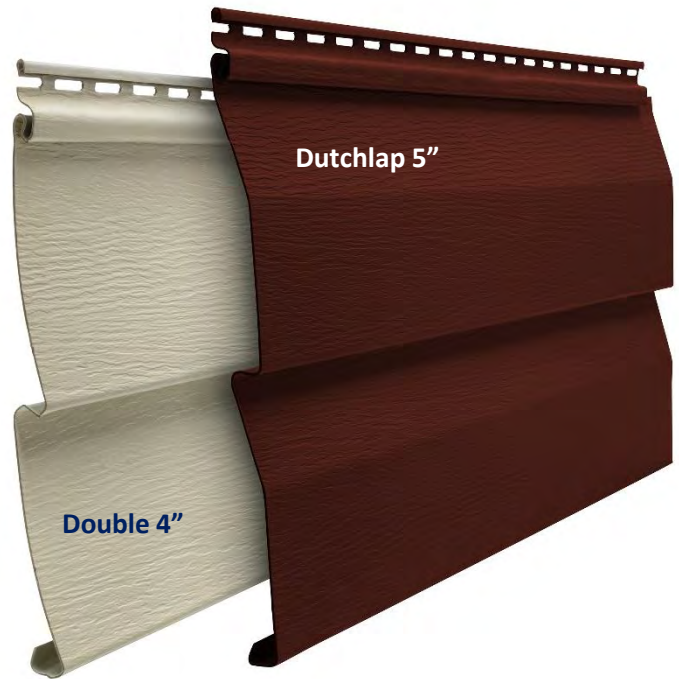

Legacy Color Selections



HERITAGE RED 87



HAMPTON BLUE 89



CANYON BROWN 81

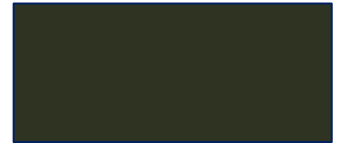

GRAY FLANNEL 90

SHUTTERS

Optional

Perrenia Shutters color is throughout and will not scratch, peel or fade. Manufactured with maintenance free high-impact polypropylene, they will not crack or dent and are proudly made in the U.S.A.. They are backed with a Limited Lifetime Warranty. They have a deeply etched natural woodgrain texture and come in an extensive color pallet providing options that compliment any taste.

Raised Panel Shutters are 14-1/2" wide and have raised panels. All lengths and widths are nominal, boxed in pairs and include a fastening system of: 12 each 3" screws, 12 each color matched SnapCap™ and 12 each color matched shutter spikes. Available in 35, 39, 47, 55, 59, 63, 67 inches long.

Color Selections



CRANBERRY



BROWN

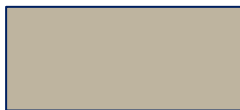

SANDSTONE



BLACK



GREEN



INDIGO BLUE



Shown in Berry

SHINGLES
Standard

- Dual-Layout Durability
- Industry Best Lifetime Limited Warranty
- 10-Year STREAKFighter® Algae-Resistance Warranty



ATLANTIC BLUE

SILVER BIRCH

COBBLESTONE GRAY

PEWTER

COLONIAL SLATE

MOIRE BLACK



COTTAGE RED



WEATHERWOOD



BURNT SIENNA



HUNTER GREEN



HEATHER BLEND



DRIFTWOOD



RESAWN SHAKE



GEORGETOWN GRAY

SHINGLES
Standard

STREAK  **Fight**er® **Algae-Resistant Shingle Technology**

The ultimate in stain protection.

Those streaks you see on other roofs in your neighborhood? That's algae, and it's a common eyesore on roofing throughout North America. CertainTeed's StreakFighter technology uses the power of science to repel algae before it can take hold and spread. StreakFighter's granular blend includes naturally algae-resistant copper, helping your roof maintain its curb appeal and look beautiful for years to come.

Granule with StreakFighter Technology

Ceramic coating

Copper layer

Mineral core

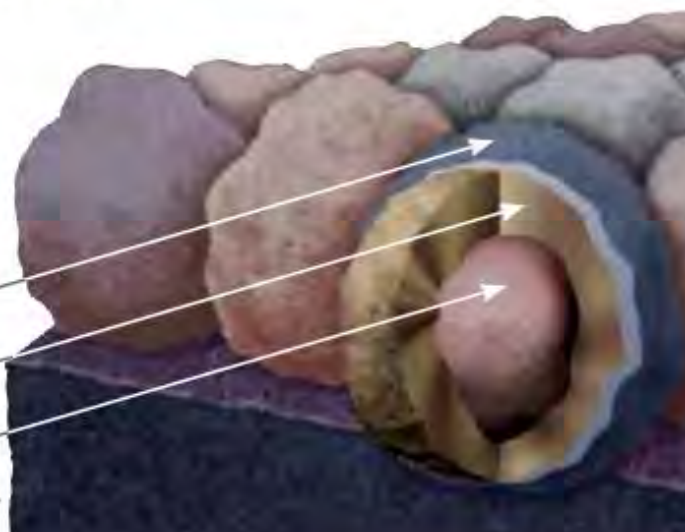

Diagram for illustrative purposes only.

SHINGLES
Standard

NAILTrak® Shingle Technology

The bond that holds it together.

For more than a decade, NailTrak has improved shingle installation by providing a nailing area three times wider than that of a typical laminate shingle. This increases efficiency and accuracy in installation, providing homeowners greater peace of mind. Landmark® shingles also feature our specially-formulated Quadra-Bond® adhesive, providing industry-leading resistance to delamination. Together, our NailTrak and Quadra-Bond technologies deliver the strength and durability that allow your roof to stand the test of time.

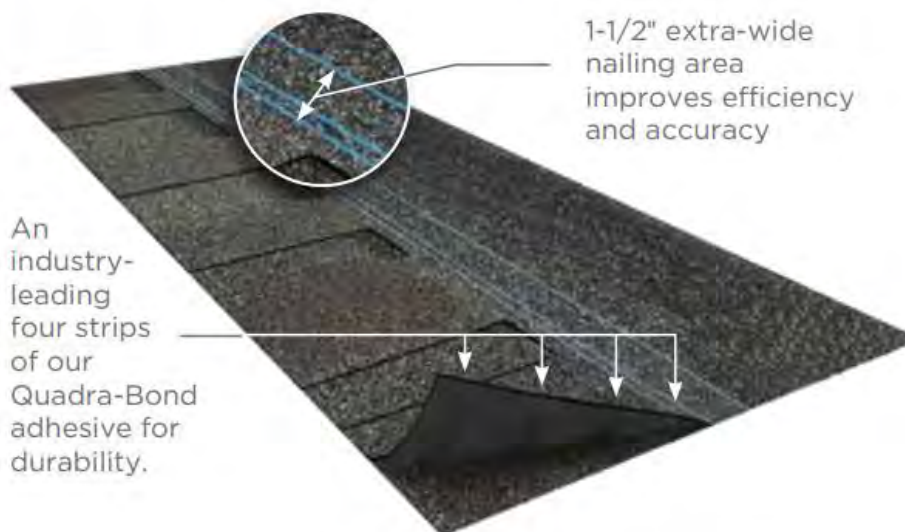

Diagram for illustrative purposes only.

EXTERIOR LIGHTS
Standard

BULBS NOT INCLUDED



DEVENS
POWDER COATED BRONZE
2651PBZ 6.5"W X 16"H



DEVENS
POWDER COATED BLACK
2651PBK 6.5"W X 16"H

EXTERIOR LIGHTS

BULBS NOT INCLUDED

Optional



POWDER COATED BRONZE
2512PBZ 9"W X 10"H



POWDER COATED BLACK
2512PBK 9"W X 10"H



POWDER COATED BRONZE
2661PBZ 7.5"W X 8"H



POWDER COATED BLACK
2661PBK 7.5"W X 8"H



BARKELEY POWDER COATED BRONZE
2601PBZ 6"W X 16"H



BARKELEY POWDER COATED BLACK
2601PBK 6"W X 16"H

VINYL SHAKES IN GABLES

Optional

NOVIKSHAKE RS8

The Rough Sawn 8' Shake panel is the most popular of the NovikShake family. Its authentic detail provides a lasting, traditional look to any structure. The NovikShake RS8 is a single course 8' panel, with features that simplify installation and authentic details that provide a lasting traditional look to any structure.

- Generates less waste on side walls and gables
- Lightweight yet rigid material
- Installs with traditional tools
- No painting, staining or caulking required
- Impervious to moisture - will not rot



Premium Color Selections



CEDAR BLEND



TRADITIONAL BLEND



WEATHERED BLEND

VINYL SHAKES IN GABLES

Optional

Color Selections

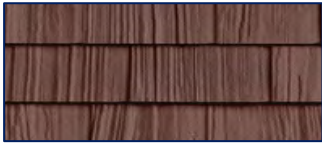

HERITAGE RED



WARM SANDALWOOD



SUNNY MAIZE

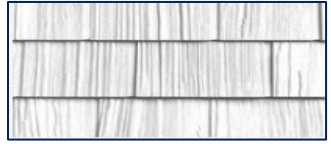

WHITE BIRCH



HAMPTON BLUE



TWILIGHT



SLATE BLUE



GRAPHITE GREY



CANYON BROWN

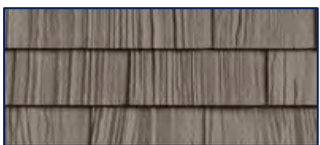

JAVA



ARTISAN CLAY

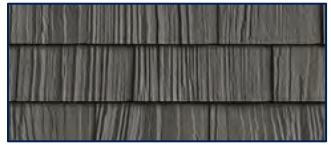

GRAY FLANNEL

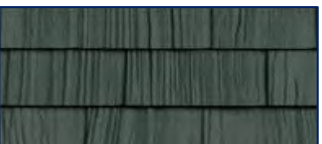

COUNTRYSIDE GREEN



SOFT WILLOW



MEADOW



DORMERS

Optional

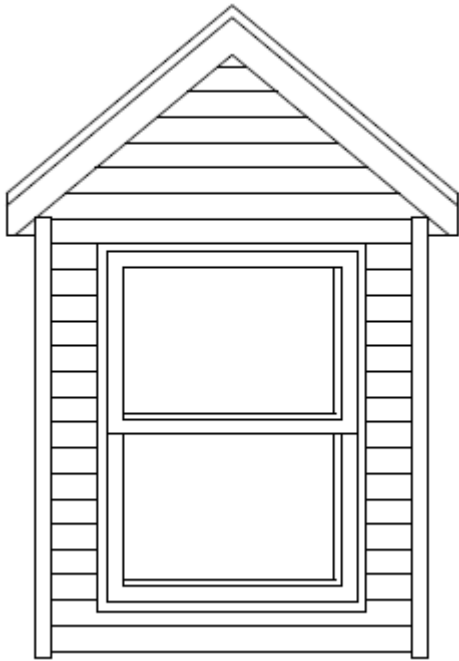

Style A

Inside Width 3'-9"

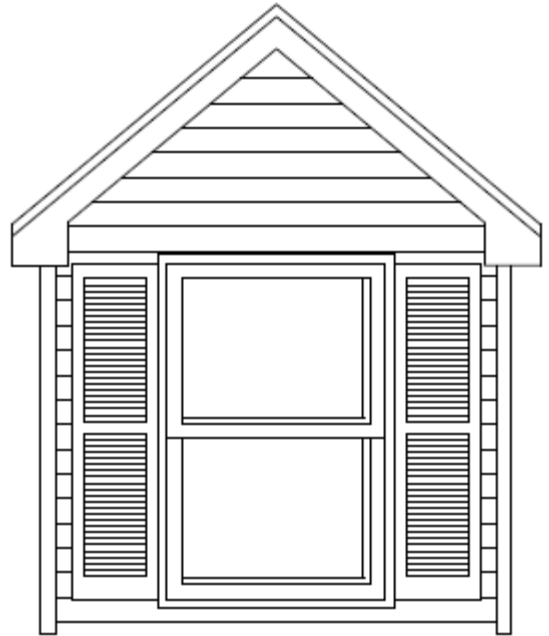

Style H

Inside Width 5'-4"

Shown with Optional
Shutters (2)

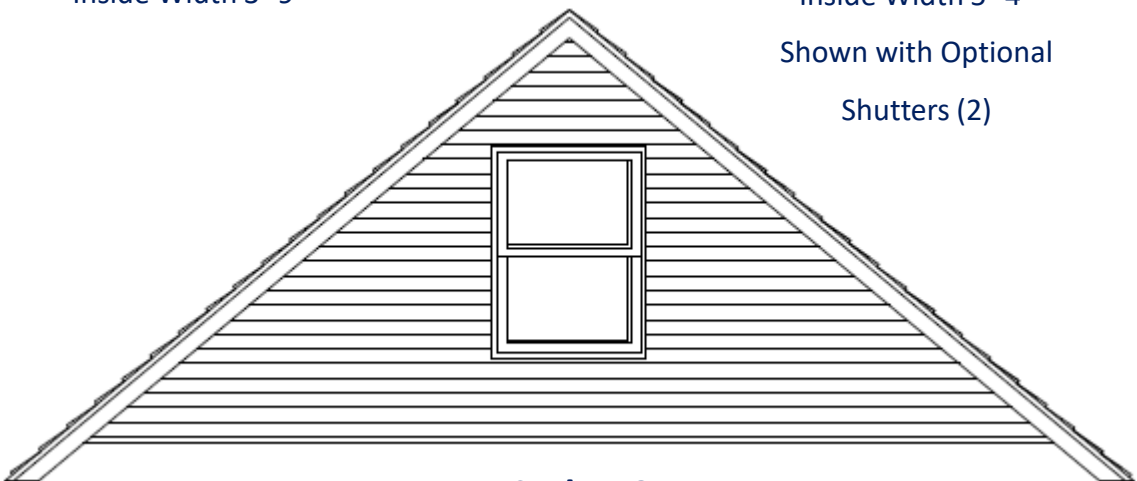

Style FG

Not Available with Shutters

All dormers include $\frac{3}{4}$ " exterior foam sheathing

DORMERS

Optional



Style J1

Inside Width 6'-10"

Shown with Optional Grilles (4)

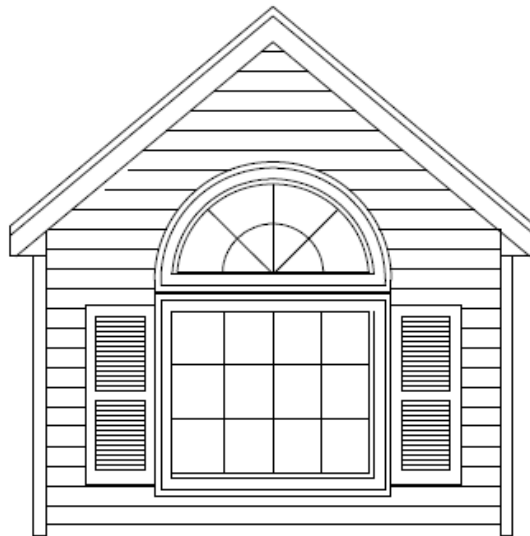

Style J2

Inside Width 6'-10"

Shown with Optional Grilles (2)

& Optional Shutters (2)

DORMERS
Optional

**Rear Shed Dormer Shown on
Berkshire Upstairs Floor**



Available on Other Select Plans

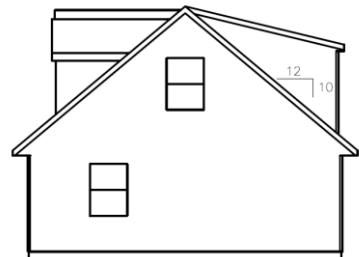
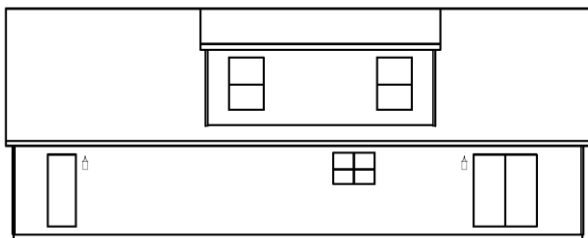



LANDMARK®

SIEMENS



FAIRFIELD VINYL SIDING



Millennium Lighting™



Clarion EVERYDAY LUXURY

ELKAY



KARRAN



Yorktowne CABINETRY



KOHLER



SINKOLOGY



LG Hausys

Viatera®





dream it. build it. love it.



Chillicothe Model Center

6473 US Route 23
Chillicothe, Ohio 45601

740-663-4800

Jackson Model Center

91 State Route 327
Jackson, Ohio 45640

740-288-9995



Henderson Model Center

6167 Kanawha Valley Road
Henderson, WV 25106

304-675-4424

www.dw-homes.com